

**Revision C:**

- MSZ-LN18VG2W/V/B/R-  E1,  EN1,  ET1,
  - MSZ-LN25VG2W/V/B/R-  E1,  EN1,  ET1,
  - MSZ-LN35VG2W/V/B/R-  E1,  EN1,  ET1,
  - MSZ-LN50VG2W/V/B/R-  E1,  EN1,  ET1
  - and MSZ-LN60VG2W/V/B/R-  E1,  ET1
- have been added.

OBH766 REVISED EDITION-B is void.

# INDOOR UNIT

# SERVICE MANUAL

**No. OBH766  
REVISED EDITION-C**

## Models

MSZ-LN18VGW -  E1  
 MSZ-LN18VGV -  E1  
 MSZ-LN18VGB -  E1  
 MSZ-LN18VGR -  E1  
 MSZ-LN18VG2W -  E1,  EN1,  ET1  
 MSZ-LN18VG2V -  E1,  EN1,  ET1  
 MSZ-LN18VG2B -  E1,  EN1,  ET1  
 MSZ-LN18VG2R -  E1,  EN1,  ET1  
 MSZ-LN25VGW -  E1,  ER1  
 MSZ-LN25VGV -  E1,  ER1  
 MSZ-LN25VGB -  E1,  ER1  
 MSZ-LN25VGR -  E1,  ER1  
 MSZ-LN25VG2W -  E1,  EN1,  ET1  
 MSZ-LN25VG2V -  E1,  EN1,  ET1  
 MSZ-LN25VG2B -  E1,  EN1,  ET1  
 MSZ-LN25VG2R -  E1,  EN1,  ET1  
 MSZ-LN35VGW -  E1,  ER1  
 MSZ-LN35VGV -  E1,  ER1  
 MSZ-LN35VGB -  E1,  ER1  
 MSZ-LN35VGR -  E1,  ER1  
 MSZ-LN35VG2W -  E1,  EN1,  ET1  
 MSZ-LN35VG2V -  E1,  EN1,  ET1  
 MSZ-LN35VG2B -  E1,  EN1,  ET1  
 MSZ-LN35VG2R -  E1,  EN1,  ET1

MSZ-LN50VGW -  E1,  ER1  
 MSZ-LN50VGV -  E1,  ER1  
 MSZ-LN50VGB -  E1,  ER1  
 MSZ-LN50VGR -  E1,  ER1  
 MSZ-LN50VG2W -  E1,  EN1,  ET1  
 MSZ-LN50VG2V -  E1,  EN1,  ET1  
 MSZ-LN50VG2B -  E1,  EN1,  ET1  
 MSZ-LN50VG2R -  E1,  EN1,  ET1  
 MSZ-LN60VGW -  E1,  ER1  
 MSZ-LN60VGV -  E1,  ER1  
 MSZ-LN60VGB -  E1,  ER1  
 MSZ-LN60VGR -  E1,  ER1  
 MSZ-LN60VG2W -  E1,  ET1  
 MSZ-LN60VG2V -  E1,  ET1  
 MSZ-LN60VG2B -  E1,  ET1  
 MSZ-LN60VG2R -  E1,  ET1

Outdoor unit service manual  
 MUZ-LN•VG Series (OBH767)  
 MUZ-LN•VGHZ Series (OBH768)



MSZ-LN25VGW/V/B/R  
 MSZ-LN35VGW/V/B/R  
 MSZ-LN50VGW/V/B/R  
 MSZ-LN60VGW/V/B/R

## CONTENTS

1. TECHNICAL CHANGES .....	2
2. PART NAMES AND FUNCTIONS.....	3
3. SPECIFICATION.....	4
4. NOISE CRITERIA CURVE .....	6
5. OUTLINES AND DIMENSIONS .....	9
6. WIRING DIAGRAM.....	10
7. REFRIGERANT SYSTEM DIAGRAM .....	13
8. SERVICE FUNCTIONS .....	14
9. MICROPROCESSOR CONTROL .....	16
10. TROUBLESHOOTING.....	27
11. DISASSEMBLY INSTRUCTIONS.....	43

**PARTS CATALOG (OBB766)**

# Use the specified refrigerant only

## Never use any refrigerant other than that specified.

Doing so may cause a burst, an explosion, or fire when the unit is being used, serviced, or disposed of.

Correct refrigerant is specified in the manuals and on the spec labels provided with our products.

We will not be held responsible for mechanical failure, system malfunction, unit breakdown or accidents caused by failure to follow the instructions.

### Revision A:

- For Wi-Fi interface, 10. TROUBLE SHOOTING has been modified.

### Revision B:

- MSZ-LN18VGW/V/B/R- [E1] have been added.

### Revision C:

- MSZ-LN18VG2W/V/B/R- [E1], [EN1], [ET1], MSZ-LN25VG2W/V/B/R- [E1], [EN1], [ET1], MSZ-LN35VG2W/V/B/R- [E1], [EN1], [ET1], MSZ-LN50VG2W/V/B/R- [E1], [EN1], [ET1] and MSZ-LN60VG2W/V/B/R- [E1], [ET1] have been added.

## 1 TECHNICAL CHANGES

### These models are compatible with the outdoor units with low standby power control.

Connecting these models to the **MUZ-LN-VG**-series outdoor units enables the low standby power control. Refer to the technical guide about the low standby power control.

These models may be connected to the **MUZ-LN-VG** series after once connected to the **MXZ** series and operated, for example because of relocation. In that case, the **MUZ-LN-VG** series outdoor units will not operate without taking a step. Follow the procedure "Deleting the memorized abnormal condition" described in 10-2.1.

<b>MSZ-LN25VGW</b> -[E1], [ER1]	<b>MSZ-LN50VGW</b> -[E1], [ER1]
<b>MSZ-LN25VGV</b> -[E1], [ER1]	<b>MSZ-LN50VGV</b> -[E1], [ER1]
<b>MSZ-LN25VGB</b> -[E1], [ER1]	<b>MSZ-LN50VGB</b> -[E1], [ER1]
<b>MSZ-LN25VGR</b> -[E1], [ER1]	<b>MSZ-LN50VGR</b> -[E1], [ER1]
<b>MSZ-LN35VGW</b> -[E1], [ER1]	<b>MSZ-LN60VGW</b> -[E1], [ER1]
<b>MSZ-LN35VGV</b> -[E1], [ER1]	<b>MSZ-LN60VGV</b> -[E1], [ER1]
<b>MSZ-LN35VGB</b> -[E1], [ER1]	<b>MSZ-LN60VGB</b> -[E1], [ER1]
<b>MSZ-LN35VGR</b> -[E1], [ER1]	<b>MSZ-LN60VGR</b> -[E1], [ER1]

1. New model

(Wi-Fi interface has been set as a standard part.)

<b>MSZ-LN18VGW</b> -[E1]	<b>MSZ-LN25VG2W</b> -[EN1], [ET1]	<b>MSZ-LN50VG2W</b> -[EN1], [ET1]
<b>MSZ-LN18VGV</b> -[E1]	<b>MSZ-LN25VG2V</b> -[EN1], [ET1]	<b>MSZ-LN50VG2V</b> -[EN1], [ET1]
<b>MSZ-LN18VGB</b> -[E1]	<b>MSZ-LN25VG2B</b> -[EN1], [ET1]	<b>MSZ-LN50VG2B</b> -[EN1], [ET1]
<b>MSZ-LN18VGR</b> -[E1]	<b>MSZ-LN25VG2R</b> -[EN1], [ET1]	<b>MSZ-LN50VG2R</b> -[EN1], [ET1]
<b>MSZ-LN18VG2W</b> -[EN1], [ET1]	<b>MSZ-LN35VG2W</b> -[EN1], [ET1]	<b>MSZ-LN60VG2W</b> -[ET1]
<b>MSZ-LN18VG2V</b> -[EN1], [ET1]	<b>MSZ-LN35VG2V</b> -[EN1], [ET1]	<b>MSZ-LN60VG2V</b> -[ET1]
<b>MSZ-LN18VG2B</b> -[EN1], [ET1]	<b>MSZ-LN35VG2B</b> -[EN1], [ET1]	<b>MSZ-LN60VG2B</b> -[ET1]
<b>MSZ-LN18VG2R</b> -[EN1], [ET1]	<b>MSZ-LN35VG2R</b> -[EN1], [ET1]	<b>MSZ-LN60VG2R</b> -[ET1]

1. New model

<b>MSZ-LN18VGW</b> -[E1]	→	<b>MSZ-LN18VG2W</b> -[E1]	<b>MSZ-LN50VGW</b> -[E1]	→	<b>MSZ-LN50VG2W</b> -[E1]
<b>MSZ-LN18VGV</b> -[E1]	→	<b>MSZ-LN18VG2V</b> -[E1]	<b>MSZ-LN50VGV</b> -[E1]	→	<b>MSZ-LN50VG2V</b> -[E1]
<b>MSZ-LN18VGB</b> -[E1]	→	<b>MSZ-LN18VG2B</b> -[E1]	<b>MSZ-LN50VGB</b> -[E1]	→	<b>MSZ-LN50VG2B</b> -[E1]
<b>MSZ-LN18VGR</b> -[E1]	→	<b>MSZ-LN18VG2R</b> -[E1]	<b>MSZ-LN50VGR</b> -[E1]	→	<b>MSZ-LN50VG2R</b> -[E1]
<b>MSZ-LN25VGW</b> -[E1]	→	<b>MSZ-LN25VG2W</b> -[E1]	<b>MSZ-LN60VGW</b> -[E1]	→	<b>MSZ-LN60VG2W</b> -[E1]
<b>MSZ-LN25VGV</b> -[E1]	→	<b>MSZ-LN25VG2V</b> -[E1]	<b>MSZ-LN60VGV</b> -[E1]	→	<b>MSZ-LN60VG2V</b> -[E1]
<b>MSZ-LN25VGB</b> -[E1]	→	<b>MSZ-LN25VG2B</b> -[E1]	<b>MSZ-LN60VGB</b> -[E1]	→	<b>MSZ-LN60VG2B</b> -[E1]
<b>MSZ-LN25VGR</b> -[E1]	→	<b>MSZ-LN25VG2R</b> -[E1]	<b>MSZ-LN60VGR</b> -[E1]	→	<b>MSZ-LN60VG2R</b> -[E1]
<b>MSZ-LN35VGW</b> -[E1]	→	<b>MSZ-LN35VG2W</b> -[E1]			
<b>MSZ-LN35VGV</b> -[E1]	→	<b>MSZ-LN35VG2V</b> -[E1]			
<b>MSZ-LN35VGB</b> -[E1]	→	<b>MSZ-LN35VG2B</b> -[E1]			
<b>MSZ-LN35VGR</b> -[E1]	→	<b>MSZ-LN35VG2R</b> -[E1]			

1. Heat exchanger has been changed.

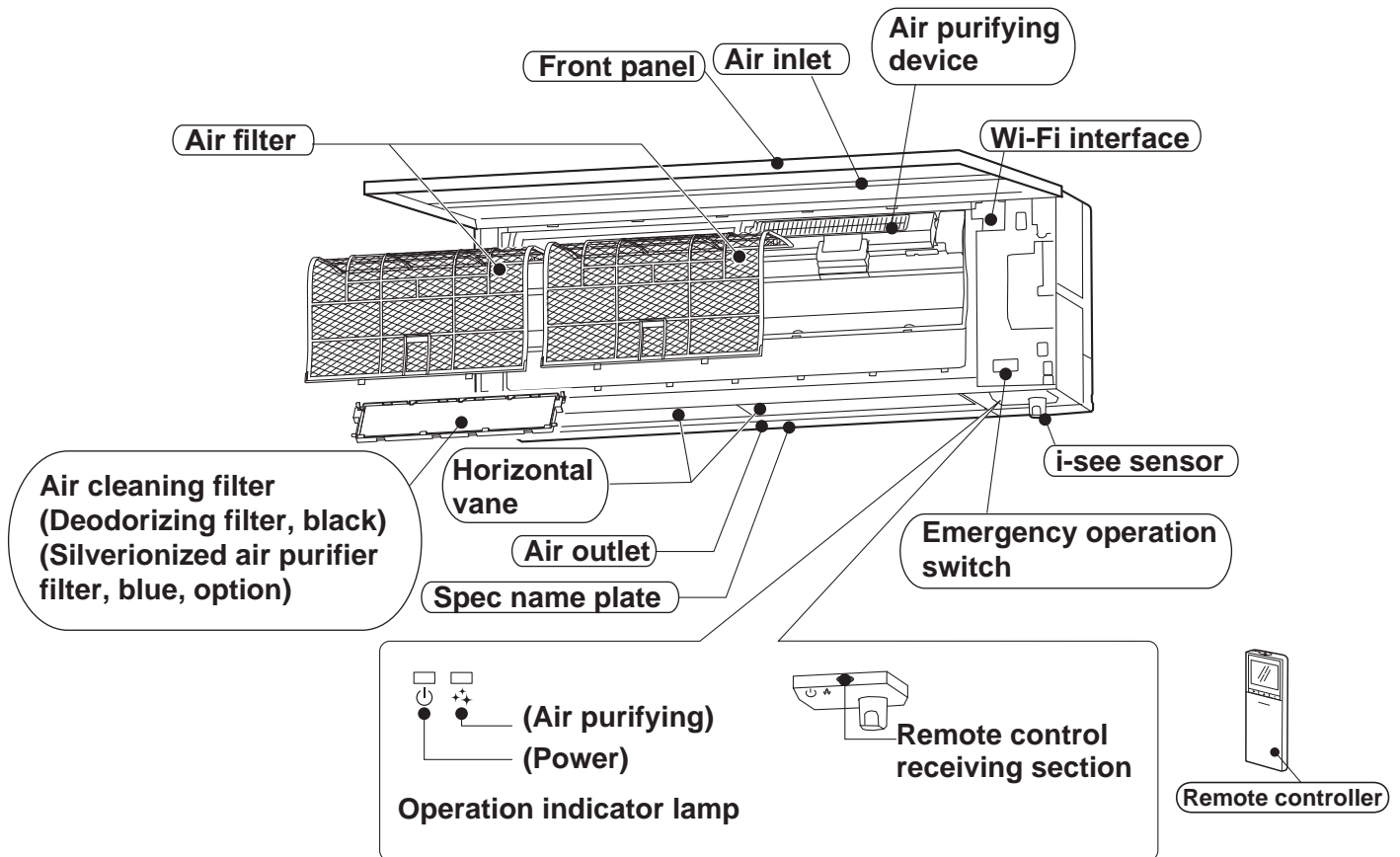
2. Refrigerant amount has been changed.

3. Remote controller has been changed.

## 2

## PART NAMES AND FUNCTIONS

MSZ-LN18VGW	MSZ-LN25VGW	MSZ-LN35VGW	MSZ-LN50VGW	MSZ-LN60VGW
MSZ-LN18VGV	MSZ-LN25VGV	MSZ-LN35VGV	MSZ-LN50VGV	MSZ-LN60VGV
MSZ-LN18VGB	MSZ-LN25VGB	MSZ-LN35VGB	MSZ-LN50VGB	MSZ-LN60VGB
MSZ-LN18VGR	MSZ-LN25VGR	MSZ-LN35VGR	MSZ-LN50VGR	MSZ-LN60VGR
MSZ-LN18VG2W	MSZ-LN25VG2W	MSZ-LN35VG2W	MSZ-LN50VG2W	MSZ-LN60VG2W
MSZ-LN18VG2V	MSZ-LN25VG2V	MSZ-LN35VG2V	MSZ-LN50VG2V	MSZ-LN60VG2V
MSZ-LN18VG2B	MSZ-LN25VG2B	MSZ-LN35VG2B	MSZ-LN50VG2B	MSZ-LN60VG2B
MSZ-LN18VG2R	MSZ-LN25VG2R	MSZ-LN35VG2R	MSZ-LN50VG2R	MSZ-LN60VG2R



### ACCESSORIES

Model	All models
① Installation plate	1
② Installation plate fixing screw 4 x 25 mm	5
③ Wireless remote controller	1
④ Felt tape (For left or left-rear piping)	1
⑤ Corner box R	4
⑥ Corner box L	4
⑦ Battery (AAA) for remote controller	2
⑧ Air cleaning filter (Deodorizing filter, black)	1
⑨ Air purifying device	1

## 3

## SPECIFICATION

Indoor model				MSZ-LN18VGW MSZ-LN18VGV MSZ-LN18VGB MSZ-LN18VGR	MSZ-LN25VGW MSZ-LN25VGV MSZ-LN25VGB MSZ-LN25VGR	MSZ-LN35VGW MSZ-LN35VGV MSZ-LN35VGB MSZ-LN35VGR	MSZ-LN50VGW MSZ-LN50VGV MSZ-LN50VGB MSZ-LN50VGR	MSZ-LN60VGW MSZ-LN60VGV MSZ-LN60VGB MSZ-LN60VGR
Power supply				Single phase 230 V, 50 Hz				
Electrical data	Power input *1	Cooling	W	20	24	29	40	
		Heating		29	34	40		
	Running current *1	Cooling	A	0.21	0.23	0.28	0.37	
		Heating		0.28	0.33	0.37		
Fan motor	Model			RC0J30-ME				
	Current *1	Cooling	A	0.21	0.23	0.28	0.37	
Heating			0.28	0.33	0.37			
Dimensions W x H x D			mm	890 x 307 x 233				
Weight			kg	15.5				
Special remarks	Air direction			5				
	Airflow	Cooling	Super High	m³/h	714	768	834	942
			High		528	636	762	
			Med.		426	528	636	
			Low		348	450	528	
			Silent		258	342	426	
		Heating	Super High	m³/h	864	822	942	942
			High		510	642	816	
			Med.		426	510	690	
			Low		342	384	564	
			Silent		240	258	324	390
	Sound level	Cooling	Super High	dB(A)	42	43	46	49
			High		36	39	45	
			Med.		29	35	41	
			Low		23	24	31	37
			Silent		19	27	29	
		Heating	Super High	dB(A)	45	47	49	49
			High		36	39	45	
			Med.		29	34	41	
			Low		24	29	37	
			Silent		19	25	29	
	Fan speed	Cooling	Super High	rpm	1,030	1,090	1,160	1,280
			High		820	940	1,080	
			Med.		700	820	940	
Low			610		730	820		
Silent			500		600	700		
Heating		Super High	rpm	1,190	1,150	1,280	1,280	
		High		800	950	1,140		
		Med.		700	800	1,000		
		Low		600	650	860		
		Silent		480	500	580	660	
Fan speed regulator			5					
Remote controller model				W: SG16L V: XG16A B: XG16C R: XG16B				

**NOTE:** Test conditions are based on ISO 5151.

Cooling: Indoor Dry-bulb temperature 27°C Wet-bulb temperature 19°C

Outdoor Dry-bulb temperature 35°C

Heating: Indoor Dry-bulb temperature 20°C

Outdoor Dry-bulb temperature 7°C Wet-bulb temperature 6°C

\*1 Measured under rated operating frequency.

### Specifications and rating conditions of main electric parts

Fuse	(F11)	T3.15AL250 V
Horizontal vane motor	(MV1)	12 V DC
Vertical vane motor	(MV2)	12 V DC
i-see SENSOR MOTOR	(MT)	12 V DC
Varistor	(NR11)	470 V
Terminal block	(TB)	3P



Indoor model			MSZ-LN18VG2W	MSZ-LN25VG2W	MSZ-LN35VG2W	MSZ-LN50VG2W	MSZ-LN60VG2W	
			MSZ-LN18VG2V	MSZ-LN25VG2V	MSZ-LN35VG2V	MSZ-LN50VG2V	MSZ-LN60VG2V	
			MSZ-LN18VG2B	MSZ-LN25VG2B	MSZ-LN35VG2B	MSZ-LN50VG2B	MSZ-LN60VG2B	
			MSZ-LN18VG2R	MSZ-LN25VG2R	MSZ-LN35VG2R	MSZ-LN50VG2R	MSZ-LN60VG2R	
Power supply			Single phase 230 V, 50 Hz					
Electrical data	Power input *1	Cooling	20		23	29	40	
		Heating	27			34	40	
	Running current *1	Cooling	0.21		0.23	0.28	0.37	
		Heating	0.26			0.33	0.37	
Fan motor	Model		RC0J40-SB			RC0J30-ME		
	Current *1	Cooling	0.21		0.23	0.28	0.37	
		Heating	0.26			0.33	0.37	
Dimensions W x H x D			mm 890 x 307 x 233					
Weight			kg W: 14.5 V, B, R: 15.5			kg W: 15 V, B, R: 16		
Special remarks	Air direction		5					
	Airflow	Cooling	Super High	744		780	834	942
			High	552			636	762
			Med.	426			528	636
			Low	354			450	528
			Silent	282			342	426
		Heating	Super High	834			942	942
			High	660			642	816
			Med.	450			510	690
			Low	396			384	564
			Silent	270			324	390
	Sound level	Cooling	Super High	42		43	46	49
			High	36			39	45
			Med.	29			35	41
			Low	23		24	31	37
			Silent	19			27	29
		Heating	Super High	45			47	49
			High	38			39	45
			Med.	29			34	41
			Low	24			29	37
			Silent	19			25	29
	Fan speed	Cooling	Super High	1,040		1,080	1,160	1,280
			High	820			940	1,080
			Med.	670			820	940
			Low	580			730	820
			Silent	500			600	700
		Heating	Super High	1,140			1,280	1,280
			High	940			950	1,140
Med.			700			800	1,000	
Low			630			650	860	
Silent			480			580	660	
Fan speed regulator			5					

	Indoor model	MSZ-LN18/25/35/50/60VG2			
		W	V	B	R
		Remote controller model	- <input type="checkbox"/> E <input type="checkbox"/> ET	SG19N	XG19D
	- <input type="checkbox"/> EN	SG19L	XG19A	XG19C	XG19B

**NOTE:** Test conditions are based on ISO 5151.

Cooling: Indoor Dry-bulb temperature 27°C Wet-bulb temperature 19°C

Outdoor Dry-bulb temperature 35°C

Heating: Indoor Dry-bulb temperature 20°C

Outdoor Dry-bulb temperature 7°C Wet-bulb temperature 6°C

\*1 Measured under rated operating frequency.

### Specifications and rating conditions of main electric parts

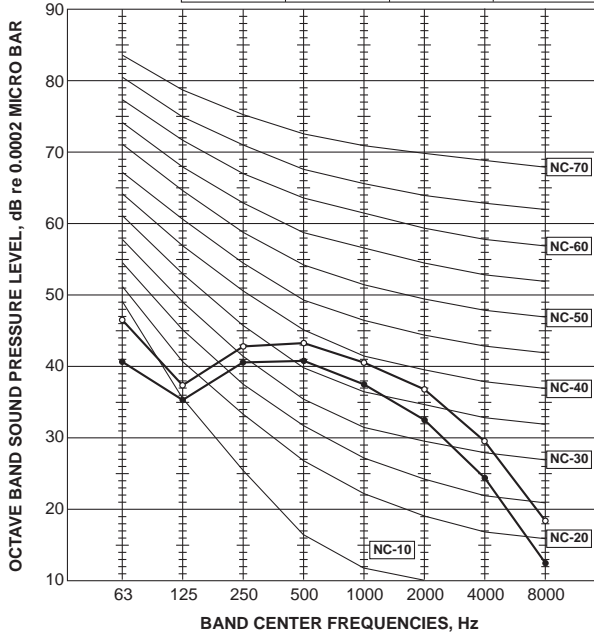
Fuse	(F11)	T3.15AL250 V
Horizontal vane motor	(MV1)	12 V DC
Vertical vane motor	(MV2)	12 V DC
i-see SENSOR MOTOR	(MT)	12 V DC
Varistor	(NR11)	470 V
Terminal block	(TB)	3P

# NOISE CRITERIA CURVE

**MSZ-LN18VGW**  
**MSZ-LN18VGV**

**MSZ-LN18VGB**  
**MSZ-LN18VGR**

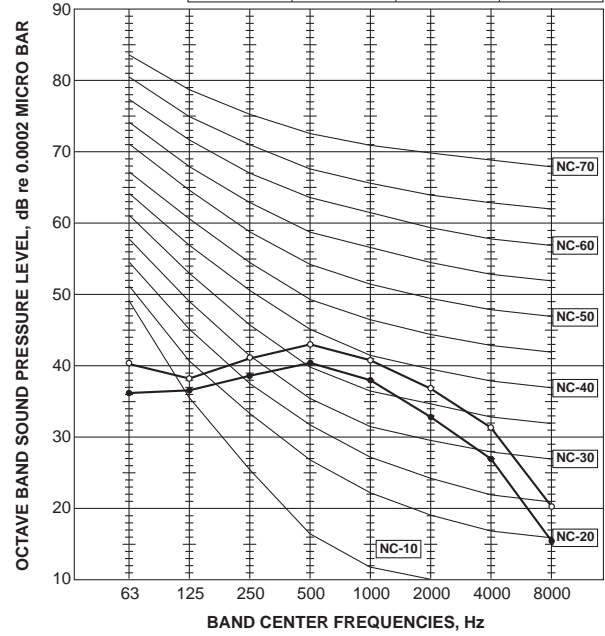
FAN SPEED	FUNCTION	SPL(dB(A))	LINE
Super High	COOLING	42	●—●
	HEATING	45	○—○



**MSZ-LN18VG2W**  
**MSZ-LN18VG2V**

**MSZ-LN18VG2B**  
**MSZ-LN18VG2R**

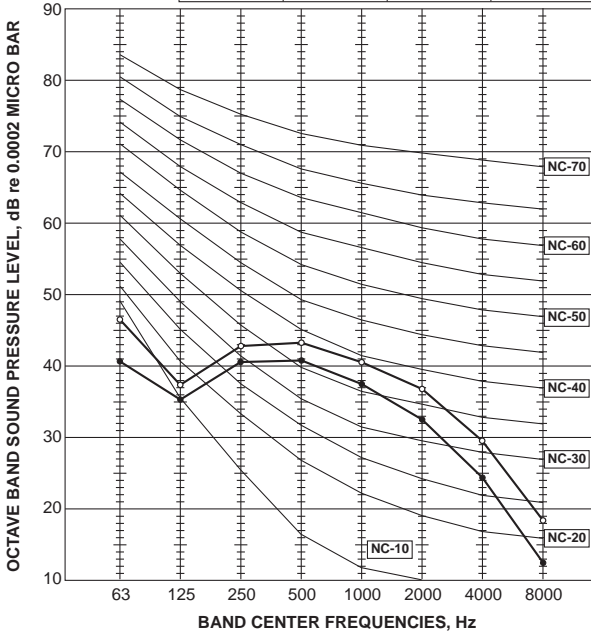
FAN SPEED	FUNCTION	SPL(dB(A))	LINE
Super High	COOLING	42	●—●
	HEATING	45	○—○



**MSZ-LN25VGW**  
**MSZ-LN25VGV**

**MSZ-LN25VGB**  
**MSZ-LN25VGR**

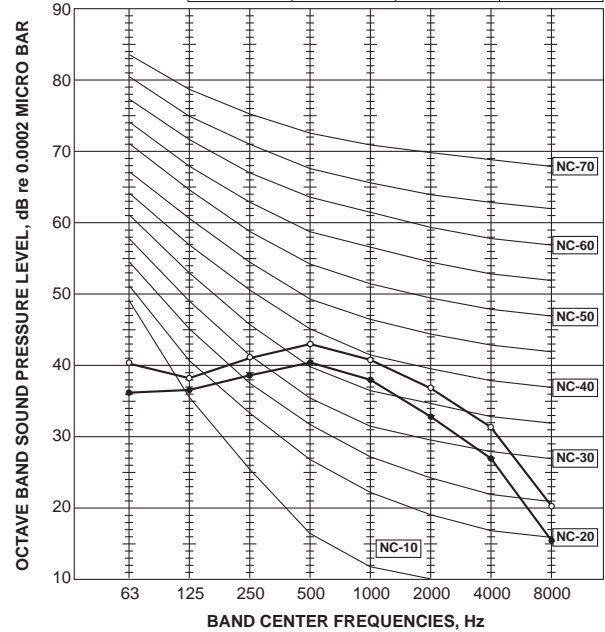
FAN SPEED	FUNCTION	SPL(dB(A))	LINE
Super High	COOLING	42	●—●
	HEATING	45	○—○



**MSZ-LN25VG2W**  
**MSZ-LN25VG2V**

**MSZ-LN25VG2B**  
**MSZ-LN25VG2R**

FAN SPEED	FUNCTION	SPL(dB(A))	LINE
Super High	COOLING	42	●—●
	HEATING	45	○—○

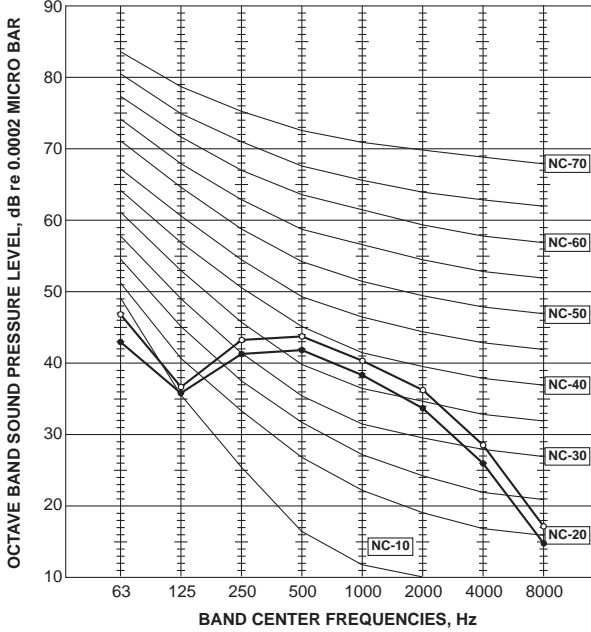




**MSZ-LN35VGW  
MSZ-LN35VGV**

**MSZ-LN35VGB  
MSZ-LN35VGR**

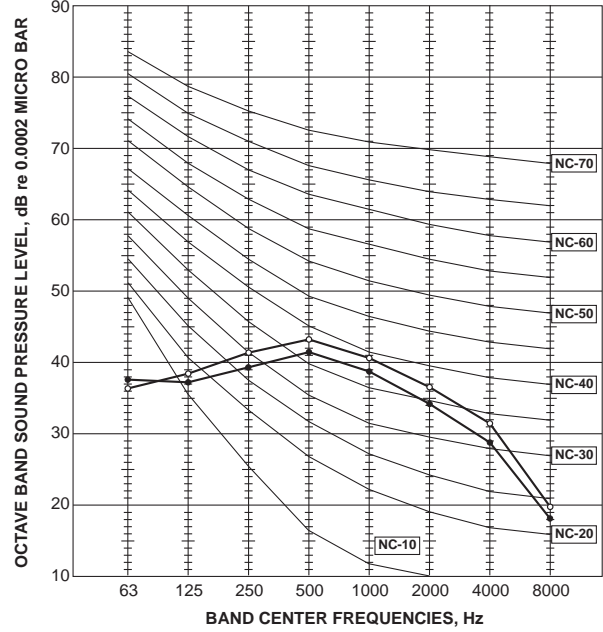
FAN SPEED	FUNCTION	SPL(dB(A))	LINE
Super High	COOLING	43	●—●
	HEATING	45	○—○



**MSZ-LN35VG2W  
MSZ-LN35VG2V**

**MSZ-LN35VG2B  
MSZ-LN35VG2R**

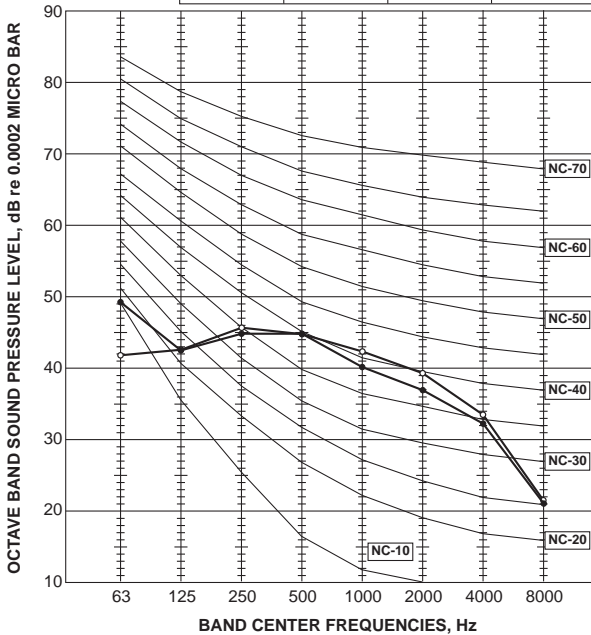
FAN SPEED	FUNCTION	SPL(dB(A))	LINE
Super High	COOLING	43	●—●
	HEATING	45	○—○



**MSZ-LN50VGW  
MSZ-LN50VGV  
MSZ-LN50VG2W  
MSZ-LN50VG2V**

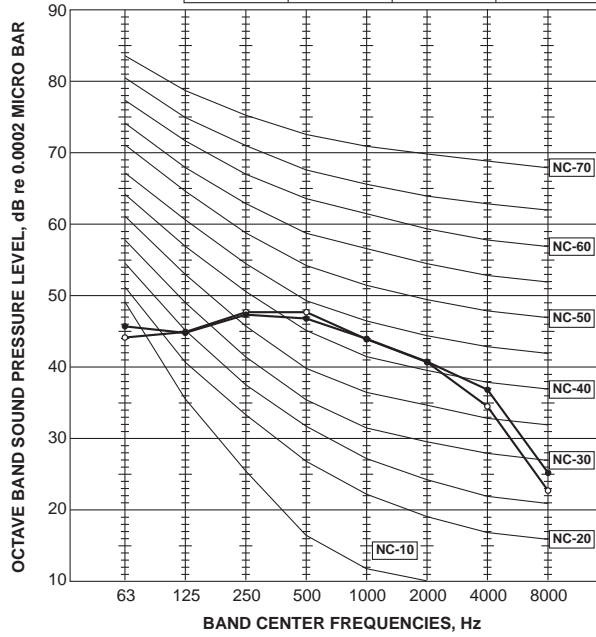
**MSZ-LN50VGB  
MSZ-LN50VGR  
MSZ-LN50VG2B  
MSZ-LN50VG2R**

FAN SPEED	FUNCTION	SPL(dB(A))	LINE
Super High	COOLING	46	●—●
	HEATING	47	○—○



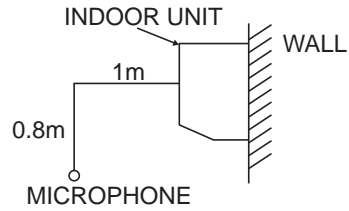
**MSZ-LN60VGW**      **MSZ-LN60VGB**  
**MSZ-LN60VGV**      **MSZ-LN60VGR**  
**MSZ-LN60VG2W**    **MSZ-LN60VG2B**  
**MSZ-LN60VG2V**    **MSZ-LN60VG2R**

FAN SPEED	FUNCTION	SPL(dB(A))	LINE
Super High	COOLING	49	●—●
	HEATING	49	○—○



**Test conditions**

Cooling: Dry-bulb temperature 27 °C  
           Wet-bulb temperature 19 °C  
 Heating: Dry-bulb temperature 20 °C



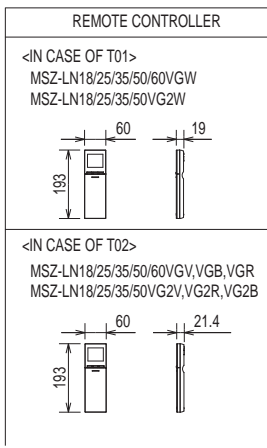
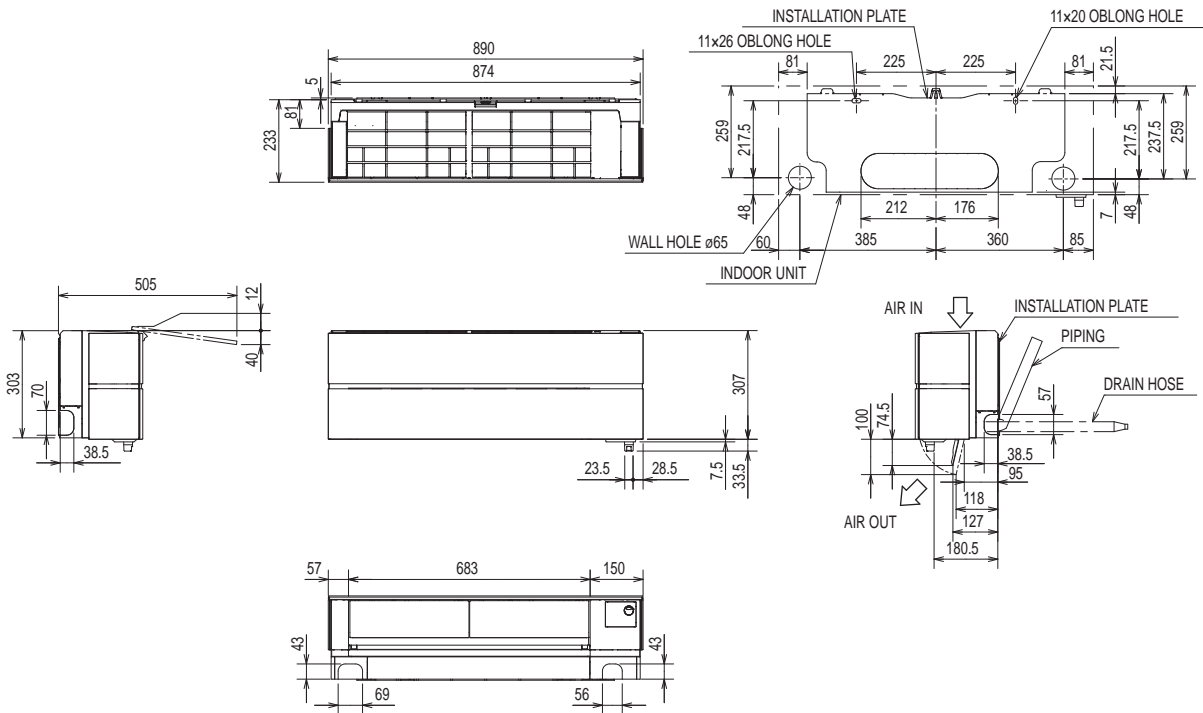


# 5

# OUTLINES AND DIMENSIONS

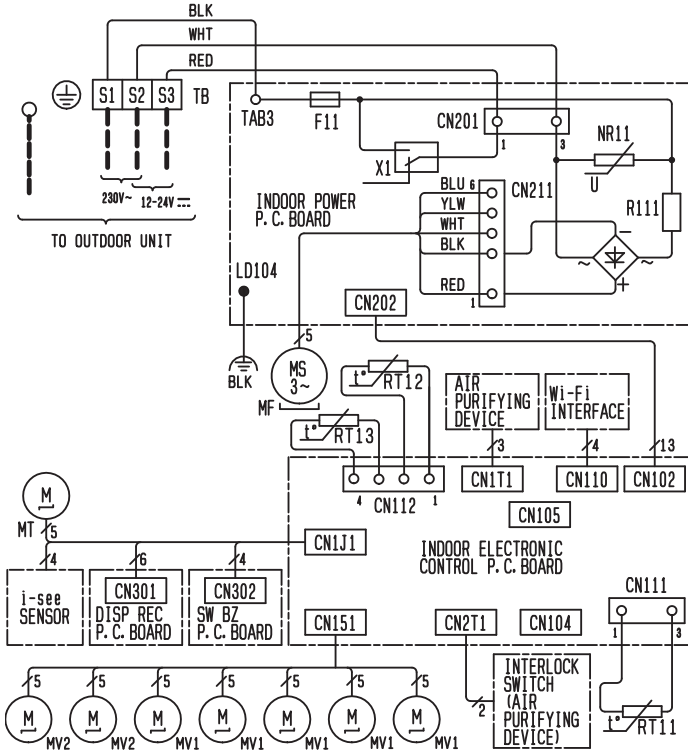
- |              |              |              |              |              |
|--------------|--------------|--------------|--------------|--------------|
| MSZ-LN18VGW  | MSZ-LN25VGW  | MSZ-LN35VGW  | MSZ-LN50VGW  | MSZ-LN60VGW  |
| MSZ-LN18VGV  | MSZ-LN25VGV  | MSZ-LN35VGV  | MSZ-LN50VGV  | MSZ-LN60VGV  |
| MSZ-LN18VGB  | MSZ-LN25VGB  | MSZ-LN35VGB  | MSZ-LN50VGB  | MSZ-LN60VGB  |
| MSZ-LN18VGR  | MSZ-LN25VGR  | MSZ-LN35VGR  | MSZ-LN50VGR  | MSZ-LN60VGR  |
| MSZ-LN18VG2W | MSZ-LN25VG2W | MSZ-LN35VG2W | MSZ-LN50VG2W | MSZ-LN60VG2W |
| MSZ-LN18VG2V | MSZ-LN25VG2V | MSZ-LN35VG2V | MSZ-LN50VG2V | MSZ-LN60VG2V |
| MSZ-LN18VG2B | MSZ-LN25VG2B | MSZ-LN35VG2B | MSZ-LN50VG2B | MSZ-LN60VG2B |
| MSZ-LN18VG2R | MSZ-LN25VG2R | MSZ-LN35VG2R | MSZ-LN50VG2R | MSZ-LN60VG2R |

Unit: mm



MSZ-LN18/25/35VGW,VGV,VGB,VGR			MSZ-LN60VGW,VGV,VGB,VGR		
PIPING	INSULATION	ø35 O.D	PIPING	INSULATION	ø37 O.D
	LIQUID LINE	ø6.35 - 0.5m (FLARED CONNECTION ø6.35)		LIQUID LINE	ø6.35 - 0.5m (FLARED CONNECTION ø6.35)
	GAS LINE	ø9.52 - 0.45m (FLARED CONNECTION ø9.52)		GAS LINE	ø9.52 - 0.45m (FLARED CONNECTION ø12.7)
DRAIN HOSE		INSULATION ø28 CONNECTED PART ø16 O.D	DRAIN HOSE		INSULATION ø28 CONNECTED PART ø16 O.D
MSZ-LN50VGW,VGV,VGB,VGR, MSZ-LN18/25/35/50VG2W,VG2V,VG2R,VG2B -E1, ET1			MSZ-LN18/25/35/50VG2W,VG2V,VG2R,VG2B -EN1		
PIPING	INSULATION	ø37 O.D	PIPING	INSULATION	ø37 O.D
	LIQUID LINE	ø6.35 - 0.5m (FLARED CONNECTION ø6.35)		LIQUID LINE	ø6.35 - 0.64m (FLARED CONNECTION ø6.35)
	GAS LINE	ø9.52 - 0.45m (FLARED CONNECTION ø9.52)		GAS LINE	ø9.52 - 0.59m (FLARED CONNECTION ø9.52)
DRAIN HOSE		INSULATION ø28 CONNECTED PART ø16 O.D	DRAIN HOSE		INSULATION ø28 CONNECTED PART ø16 O.D

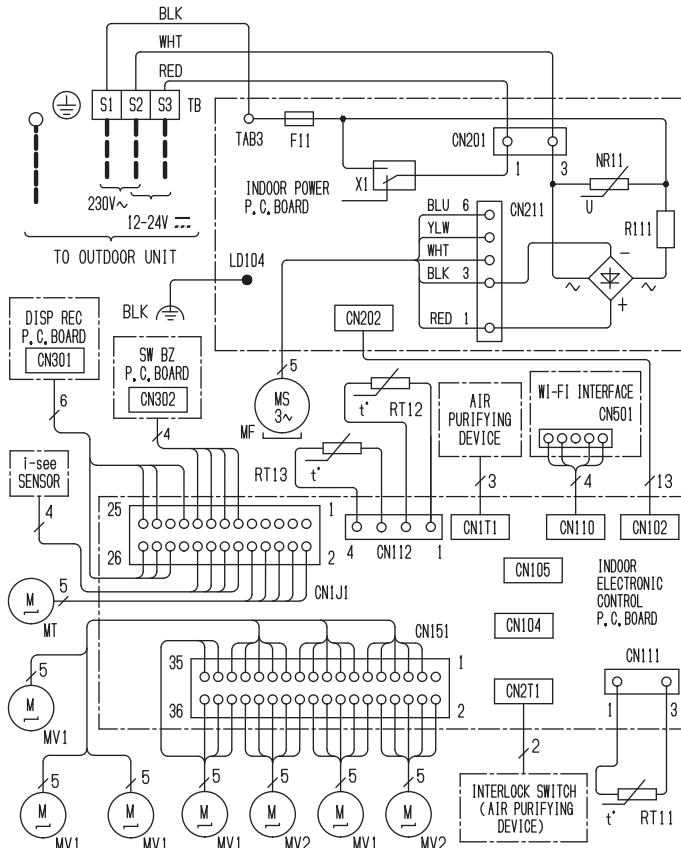
- MSZ-LN18VGW    MSZ-LN25VGW    MSZ-LN35VGW    MSZ-LN60VGW
- MSZ-LN18VGV    MSZ-LN25VGV    MSZ-LN35VGV    MSZ-LN60VGV
- MSZ-LN18VGB    MSZ-LN25VGB    MSZ-LN35VGB    MSZ-LN60VGB
- MSZ-LN18VGR    MSZ-LN25VGR    MSZ-LN35VGR    MSZ-LN60VGR



SYMBOL	NAME
F11	FUSE (T3, 15A/250V)
MF	FAN MOTOR
MV1	VANE MOTOR (HORIZONTAL)
MV2	VANE MOTOR (VERTICAL)
MT	i-see SENSOR MOTOR
NR11	VARISTOR
R111	RESISTOR
RT11	ROOM TEMP. THERMISTOR
RT12	COIL TEMP. THERMISTOR (MAIN)
RT13	COIL TEMP. THERMISTOR (SUB)
TB	TERMINAL BLOCK
X1	RELAY

NOTES: 1. About the outdoor side electronic wiring refer to the outdoor unit electronic wiring diagram for servicing.  
 2. Use copper supply wires.  
 3. Symbols indicate. □ : Terminal block    ⊞ : Connector

- MSZ-LN18VG2W-[E1, EN1]    MSZ-LN25VG2W-[E1, EN1]    MSZ-LN35VG2W-[E1, EN1]    MSZ-LN60VG2W-[E1, EN1]
- MSZ-LN18VG2V-[E1, EN1]    MSZ-LN25VG2V-[E1, EN1]    MSZ-LN35VG2V-[E1, EN1]    MSZ-LN60VG2V-[E1, EN1]
- MSZ-LN18VG2B-[E1, EN1]    MSZ-LN25VG2B-[E1, EN1]    MSZ-LN35VG2B-[E1, EN1]    MSZ-LN60VG2B-[E1, EN1]
- MSZ-LN18VG2R-[E1, EN1]    MSZ-LN25VG2R-[E1, EN1]    MSZ-LN35VG2R-[E1, EN1]    MSZ-LN60VG2R-[E1, EN1]



SYMBOL	NAME
F11	FUSE (T3, 15A/250V)
MF	FAN MOTOR
MV1	VANE MOTOR (HORIZONTAL)
MV2	VANE MOTOR (VERTICAL)
MT	i-see SENSOR MOTOR
NR11	VARISTOR
R111	RESISTOR
RT11	ROOM TEMP. THERMISTOR
RT12	COIL TEMP. THERMISTOR (MAIN)
RT13	COIL TEMP. THERMISTOR (SUB)
TB	TERMINAL BLOCK
X1	RELAY

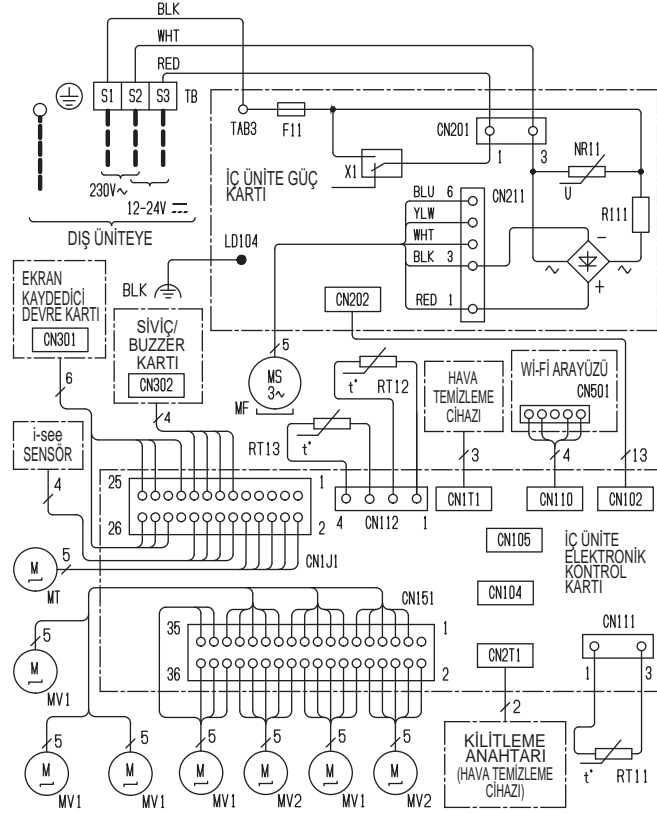
NOTES: 1. About the outdoor side electronic wiring refer to the outdoor unit electronic wiring diagram for servicing.  
 2. Use copper supply wires.  
 3. Symbols indicate. □ : Terminal block    ⊞ : Conn

MSZ-LN18VG2W-ET1  
MSZ-LN18VG2V-ET1  
MSZ-LN18VG2B-ET1  
MSZ-LN18VG2R-ET1

MSZ-LN25VG2W-ET1  
MSZ-LN25VG2V-ET1  
MSZ-LN25VG2B-ET1  
MSZ-LN25VG2R-ET1



MSZ-LN35VG2W-ET1  
MSZ-LN35VG2V-ET1  
MSZ-LN35VG2B-ET1  
MSZ-LN35VG2R-ET1

MSZ-LN60VG2W-ET1  
MSZ-LN60VG2V-ET1  
MSZ-LN60VG2B-ET1  
MSZ-LN60VG2R-ET1

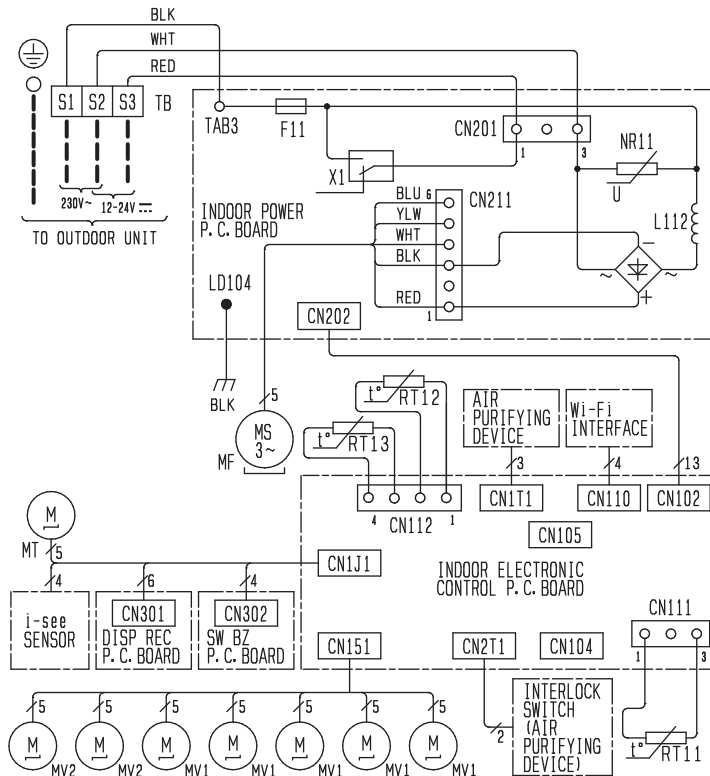


SEMBOL	PARÇA ADI
F11	SİĞORTA (T3.15A/250V)
MF	FAN MOTORU
MV1	KANAT MOTORU (YATAY)
MV2	KANAT MOTORU (DİKEY)
MT	i-see SENSÖR MOTORU
NR11	VARİSTÖR
R111	RESİTÖR
RT11	ODA SICAKLIK TERMİSTÖRÜ
RT12	BORU SICAKLIK TERMİSTÖRÜ (ANA)
RT13	BORU SICAKLIK TERMİSTÖRÜ (YARDIMCI)
TB	TERMINAL BLOĞU
X1	RÖLE



#### NOTLAR:

1. Dış ünite elektronik kablolması için dış ünite elektronik kablo devre şemasını referans alınız.
2. Sadece bakır besleme kablosu kullanın
3. Sembollerini gösterir  : Terminal bloğu  : Konektör

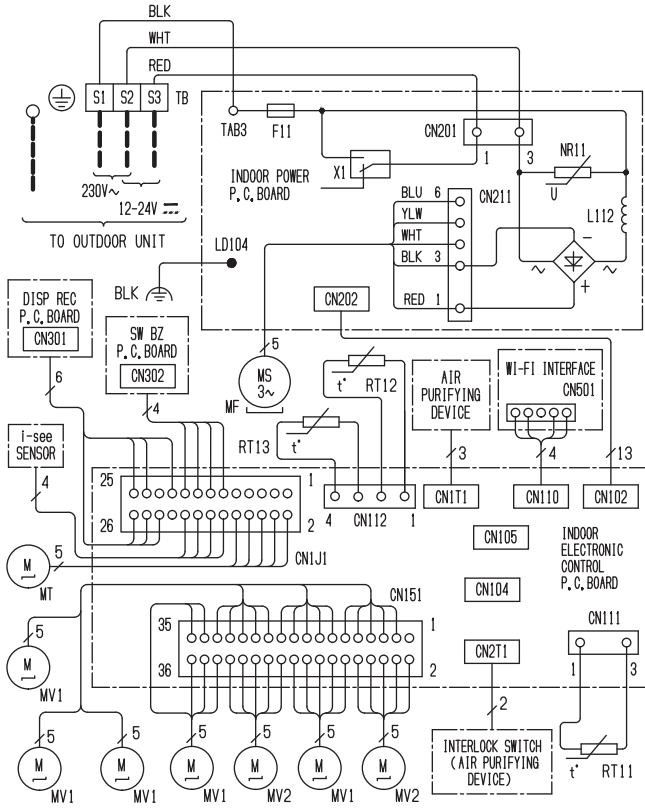
MSZ-LN50VGW  
MSZ-LN50VGV  
MSZ-LN50VGB  
MSZ-LN50VGR



SYMBOL	NAME
F11	FUSE (T3.15A/250V)
MF	FAN MOTOR
MV1	VANE MOTOR (HORIZONTAL)
MV2	VANE MOTOR (VERTICAL)
MT	i-see SENSOR MOTOR
NR11	VARISTOR
L112	REACTOR
RT11	ROOM TEMP. THERMISTOR
RT12	COIL TEMP. THERMISTOR (MAIN)
RT13	COIL TEMP. THERMISTOR (SUB)
TB	TERMINAL BLOCK
X1	RELAY

- NOTES: 1. About the outdoor side electronic wiring refer to the outdoor unit electronic wiring diagram for servicing.  
2. Use copper conductors only. (For field wiring)  
3. Symbols indicate.  : Terminal block  : Connector

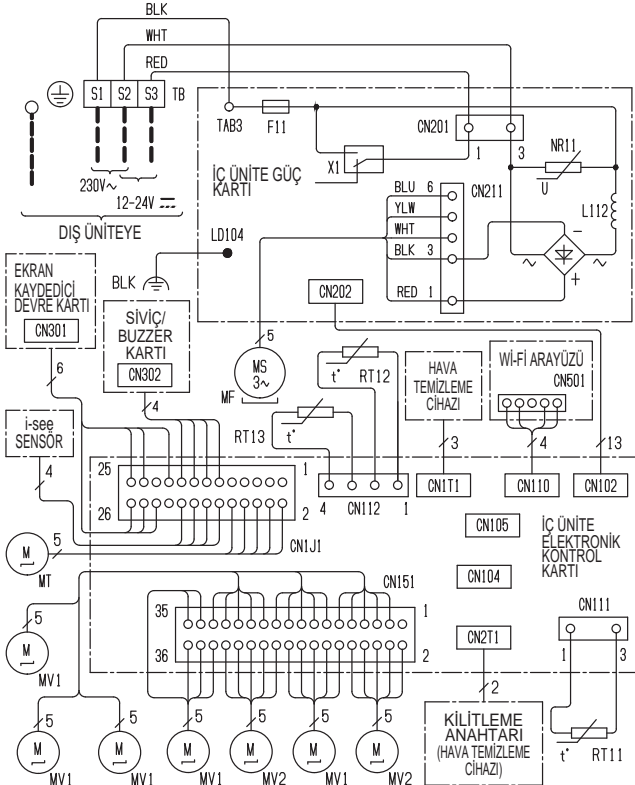
**MSZ-LN50VG2W** - [E1], [EN1]  
**MSZ-LN50VG2V** - [E1], [EN1]  
**MSZ-LN50VG2B** - [E1], [EN1]  
**MSZ-LN50VG2R** - [E1], [EN1]



SYMBOL	NAME
F11	FUSE (T3, 15AL, 250V)
MF	FAN MOTOR
MV1	VANE MOTOR (HORIZONTAL)
MV2	VANE MOTOR (VERTICAL)
MT	i-see SENSOR MOTOR
NR11	VARISTOR
L112	REACTOR
RT11	ROOM TEMP. THERMISTOR
RT12	COIL TEMP. THERMISTOR (MAIN)
RT13	COIL TEMP. THERMISTOR (SUB)
TB	TERMINAL BLOCK
X1	RELAY

NOTES: 1. About the outdoor side electronic wiring refer to the outdoor unit electronic wiring diagram for servicing.  
2. Use copper supply wires.  
3. Symbols indicate, □ : Terminal block ○ : Connector

**MSZ-LN50VG2W** - [ET1]  
**MSZ-LN50VG2V** - [ET1]  
**MSZ-LN50VG2B** - [ET1]  
**MSZ-LN50VG2R** - [ET1]



SEMBOL	PARÇA ADI
F11	SİĞORTA (T3, 15AL, 250V)
MF	FAN MOTORU
MV1	KANAT MOTORU (YATAY)
MV2	KANAT MOTORU (DİKEY)
MT	i-see SENSÖR MOTORU
NR11	VARİSTÖR
L112	REAKTÖR
RT11	ODA SICAKLIK TERMİSTÖRÜ
RT12	BORU SICAKLIK TERMİSTÖRÜ (ANA)
RT13	BORU SICAKLIK TERMİSTÖRÜ (YARDIMCI)
TB	TERMINAL BLOĞU
X1	RÖLE

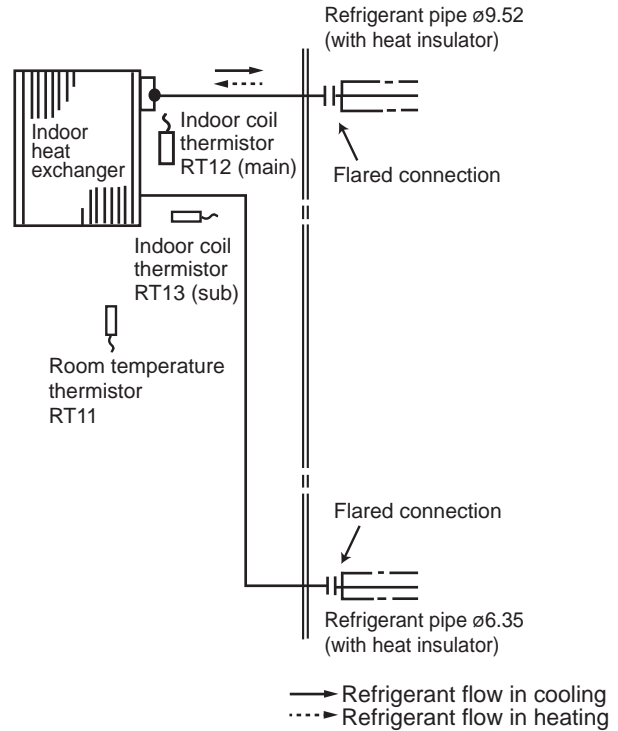
NOTLAR:  
1. Dış ünite elektronik kablolaması için dış ünite elektronik kablo devre şemasını referans alınınız.  
2. Sadece bakır besleme kablosu kullanınız  
3. Sembollerini gösterir □ : Terminal bloğu ○ : Konektör

# 7

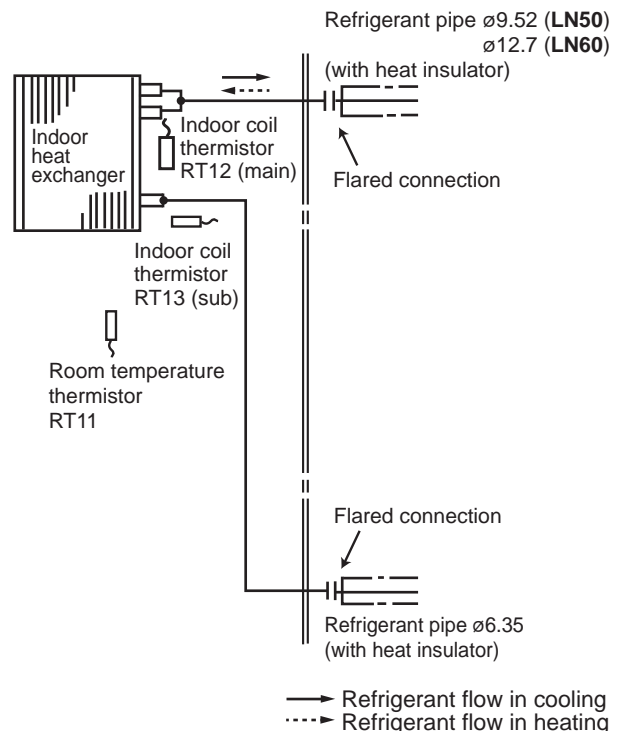
# REFRIGERANT SYSTEM DIAGRAM

MSZ-LN18VGW	MSZ-LN25VGW	MSZ-LN35VGW
MSZ-LN18VGV	MSZ-LN25VGV	MSZ-LN35VGV
MSZ-LN18VGB	MSZ-LN25VGB	MSZ-LN35VGB
MSZ-LN18VGR	MSZ-LN25VGR	MSZ-LN35VGR
MSZ-LN18VG2W	MSZ-LN25VG2W	MSZ-LN35VG2W
MSZ-LN18VG2V	MSZ-LN25VG2V	MSZ-LN35VG2V
MSZ-LN18VG2B	MSZ-LN25VG2B	MSZ-LN35VG2B
MSZ-LN18VG2R	MSZ-LN25VG2R	MSZ-LN35VG2R

Unit: mm



MSZ-LN50VGW	MSZ-LN60VGW
MSZ-LN50VGV	MSZ-LN60VGV
MSZ-LN50VGB	MSZ-LN60VGB
MSZ-LN50VGR	MSZ-LN60VGR
MSZ-LN50VG2W	MSZ-LN60VG2W
MSZ-LN50VG2V	MSZ-LN60VG2V
MSZ-LN50VG2B	MSZ-LN60VG2B
MSZ-LN50VG2R	MSZ-LN60VG2R



MSZ-LN18VGW MSZ-LN25VGW MSZ-LN35VGW MSZ-LN50VGW MSZ-LN60VGW  
 MSZ-LN18VGV MSZ-LN25VGV MSZ-LN35VGV MSZ-LN50VGV MSZ-LN60VGV  
 MSZ-LN18VGB MSZ-LN25VGB MSZ-LN35VGB MSZ-LN50VGB MSZ-LN60VGB  
 MSZ-LN18VGR MSZ-LN25VGR MSZ-LN35VGR MSZ-LN50VGR MSZ-LN60VGR  
 MSZ-LN18VG2W MSZ-LN25VG2W MSZ-LN35VG2W MSZ-LN50VG2W MSZ-LN60VG2W  
 MSZ-LN18VG2V MSZ-LN25VG2V MSZ-LN35VG2V MSZ-LN50VG2V MSZ-LN60VG2V  
 MSZ-LN18VG2B MSZ-LN25VG2B MSZ-LN35VG2B MSZ-LN50VG2B MSZ-LN60VG2B  
 MSZ-LN18VG2R MSZ-LN25VG2R MSZ-LN35VG2R MSZ-LN50VG2R MSZ-LN60VG2R

### 8-1. TIMER SHORT MODE

For service, the following set time can be shortened by bridging the timer short mode point on the electronic control P.C. board.

(Refer to 10-7.)

- The set time for the ON/OFF timer can be reduced to 1 second for each minute.
- After the breaker is turned on, the time for starting the compressor, which normally takes 3 minutes, can be reduced to 1 minute. Restarting the compressor, which takes 3 minutes, cannot be reduced.





### 8-2. HOW TO SET REMOTE CONTROLLER EXCLUSIVELY FOR A PARTICULAR INDOOR UNIT

A maximum of 4 indoor units with wireless remote controllers can be used in a room.

To operate the indoor units individually with each remote controller, assign a number to each remote controller according to the number of the indoor unit.

**This setting can be set only when all the following conditions are met:**

- The remote controller is powered OFF.
- Weekly timer is not set.
- Weekly timer is not being edited.

- (1) Hold down  button on the remote controller for 2 seconds to enter the pairing mode.
- (2) Press  button again and assign a number to each remote controller.  
Each press of  button advances the number in the following order: 1 → 2 → 3 → 4.
- (3) Press  button to complete the pairing setting.

After you turn the breaker ON, the remote controller that first sends a signal to an indoor unit will be regarded as the remote controller for the indoor unit.

Once they are set, the indoor unit will only receive the signal from the assigned remote controller afterwards.

### 8-3. SETTING THE INSTALLATION POSITION

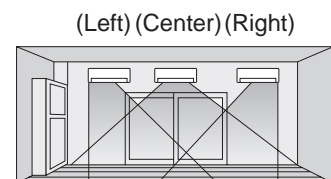
Be sure to set the remote controller according to the installed position of the indoor unit.

**Installation position:**

Left: Distance to objects (wall, cabinet, etc.) is less than 50 cm to the left





Center: Distance to objects (wall, cabinet, etc.) is more than 50 cm to the left and right




Right: Distance to objects (wall, cabinet, etc.) is less than 50 cm to the right



**The installation position can be set only when all the following conditions are met:**

- The remote controller is powered OFF.
- Weekly timer is not set.
- Weekly timer is not being edited.

- (1) Hold down  button on the remote controller for 2 seconds to enter the position setting mode.
- (2) Select the target installation position by pressing  button. (Each press of the  button displays the positions in order: center → right → left.)
- (3) Press  button to complete the position setting.

Installation position	Left	Center	Right
Remote controller display			

## 8-4. AUTO RESTART FUNCTION

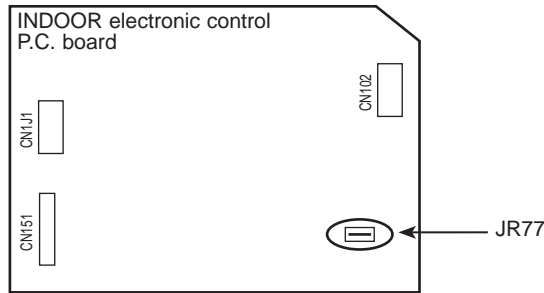
When the indoor unit is controlled with the remote controller, the operation mode, the set temperature, and the fan speed are memorized by the indoor electronic control P.C. board. "AUTO RESTART FUNCTION" automatically starts operation in the same mode just before the shutoff of the main power.

### Operation

- ① If the main power has been cut, the operation settings remain.
- ② After the power is restored, the unit restarts automatically according to the memory.  
(However, it takes at least 3 minutes for the compressor to start running.)

### How to disable "AUTO RESTART FUNCTION"

- ① Turn off the main power for the unit.
- ② Cut the jumper wire to JR77 on the indoor electronic control P.C. board. (Refer to 10-7.)

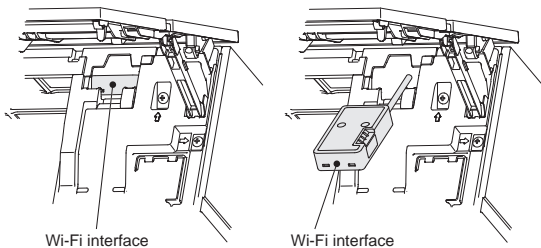


### NOTE:

- The operation settings are memorized when 10 seconds have passed after the indoor unit was operated with the remote controller.
- If main power is turned OFF or a power failure occurs while AUTO START/STOP timer is active, the timer setting is cancelled.
- If the unit has been turned OFF with the remote controller before power failure, the auto restart function does not work as the power button of the remote controller is OFF.
- To prevent the breaker from tripping OFF due to the rush of starting current, systematize other home appliance not to turn ON at the same time.
- When some air conditioners are connected to the same supply system, if they are operated before power failure, the starting current of all the compressors may flow simultaneously at restart.  
Therefore, the special counter-measures are required to prevent the main voltage-drop or the rush of the starting current by adding to the system that allows the units to start one by one.

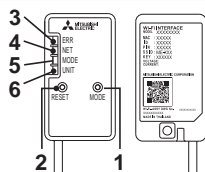
## 8-5. Wi-Fi INTERFACE SETTING UP

This Wi-Fi interface communicates the status information and controls the commands from the MELCloud by connecting to an indoor unit.



### Wi-Fi interface introduction

No.	Item	Description
1	MODE switch	It selects modes.
2	RESET switch	It resets the system and ALL settings.
3	ERR LED (Orange)	It shows the network error state.
4	NET LED (Green)	It shows the network state.
5	MODE LED (Orange)	It shows the Access point mode state.
6	UNIT LED (Green)	It shows the indoor unit state.



- (1) MODE switch
  - The MODE switch is used for selecting modes in configurations.
- (2) RESET switch
  - Hold down the RESET switch for 2 seconds to reboot the system.
  - Hold down the RESET switch for 14 seconds to initialize the Wi-Fi interface to the factory default.

### NOTE:

When the Wi-Fi interface is reset to the factory default, ALL the configuration information will be lost. Take great care in implementing this operation.

- (1) Open the front panel and remove the Wi-Fi interface.
- (2) Set up a connection between the Wi-Fi interface and the router.  
Refer to the SETUP MANUAL and SETUP QUICK REFERENCE GUIDE provided with the unit.

For SETUP MANUAL, please go to the website below.  
<http://www.melcloud.com/Support>

- (3) Put the Wi-Fi interface back and close the front panel after the setup is completed.
- (4) For MELCloud User Manual, please go to the website below.  
<http://www.melcloud.com/Support>

### NOTE:

- Ensure that the Router supports the WPA2-AES encryption setting before starting the Wi-Fi interface setup.
- The End user should read and accept the terms and conditions of the Wi-Fi service before using this Wi-Fi interface.
- To complete connection of this Wi-Fi interface to the Wi-Fi service, the Router may be required.
- This Wi-Fi interface will not commence transmission of any operational data from the system until the End user registers and accepts the terms and conditions of the Wi-Fi service.
- This Wi-Fi interface should not be installed and connected to any Mitsubishi Electric system which is to provide application critical cooling or heating.
- At the time of relocation or disposal, reset the Wi-Fi interface to the factory default.

Mitsubishi Electric's Wi-Fi interface is designed for communication to Mitsubishi Electric's MELCloud Wi-Fi service.  
Third party Wi-Fi interfaces cannot be connected to MELCloud.  
Mitsubishi Electric is not responsible for any (i) under performance of a system or any product; (ii) system or product fault; or (iii) loss or damage to any system or product; which is caused by or arises from connection to and/or use of any third party Wi-Fi interface or any third party Wi-Fi service with Mitsubishi Electric equipment.

For the latest information regarding MELCloud from Mitsubishi Electric Corporation, please visit [www.MELCloud.com](http://www.MELCloud.com).

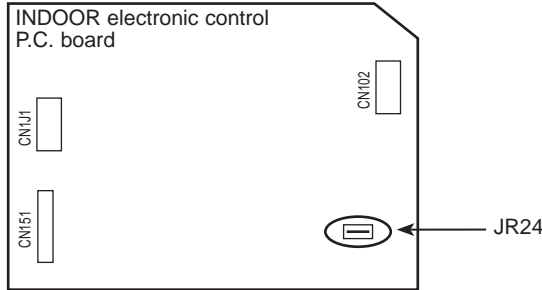


## 8-6. CHANGING THE CORRECTION VALUE OF THE ROOM TEMPERATURE

Cut the jumper wire JR24 when the room temperature does not reach the set temperature during heating operation. (Refer to 10-7.)

Cutting the jumper wire JR24 changes the correction value of the room temperature during heating operation from -2°C to -5°C and lets the AUTO fan speed of the indoor unit and the compressor frequency increase easily.

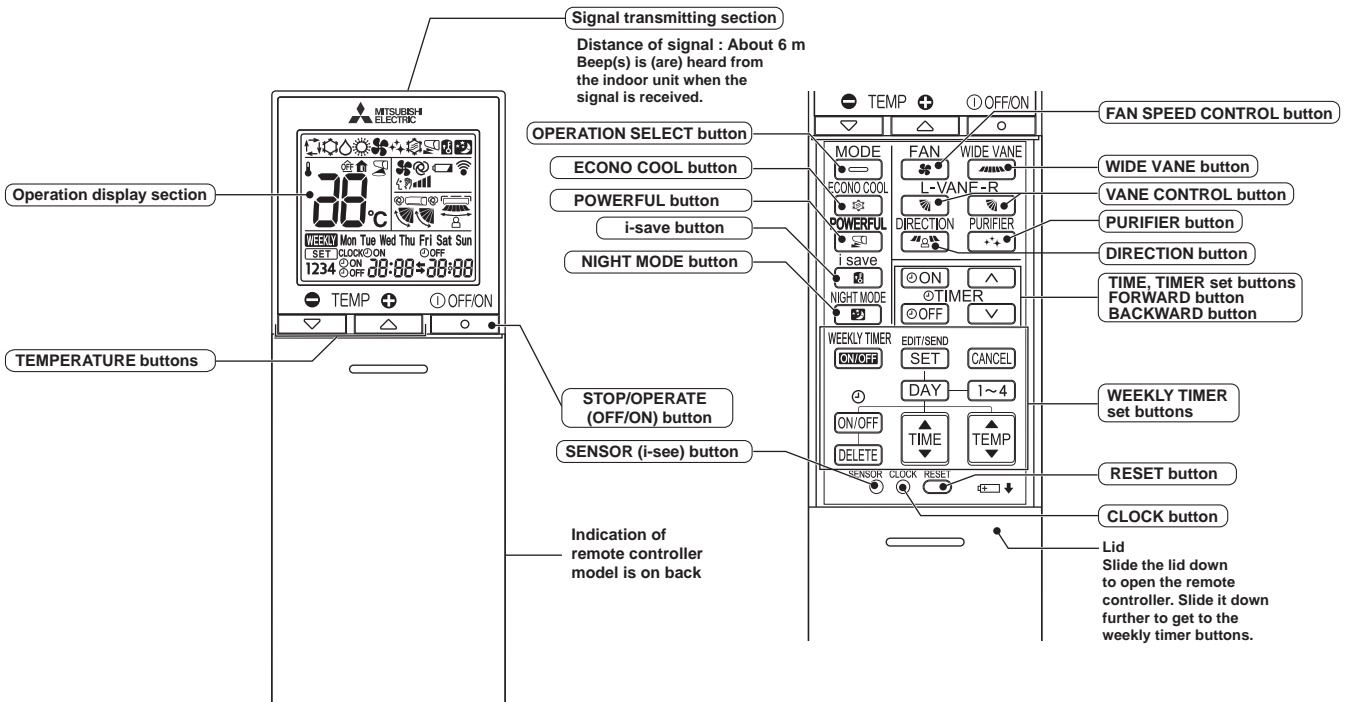
The applicable models are MSZ-LN\*\*VG2W, MSZ-LN\*\*VG2V, MSZ-LN\*\*VG2B, and MSZ-LN\*\*VG2R.



## 9 MICROPROCESSOR CONTROL

MSZ-LN18VGW	MSZ-LN25VGW	MSZ-LN35VGW	MSZ-LN50VGW	MSZ-LN60VGW
MSZ-LN18VGV	MSZ-LN25VGV	MSZ-LN35VGV	MSZ-LN50VGV	MSZ-LN60VGV
MSZ-LN18VGB	MSZ-LN25VGB	MSZ-LN35VGB	MSZ-LN50VGB	MSZ-LN60VGB
MSZ-LN18VGR	MSZ-LN25VGR	MSZ-LN35VGR	MSZ-LN50VGR	MSZ-LN60VGR
MSZ-LN18VG2W- <sup>[E1]</sup> <sub>[ET1]</sub>	MSZ-LN25VG2W- <sup>[E1]</sup> <sub>[ET1]</sub>	MSZ-LN35VG2W- <sup>[E1]</sup> <sub>[ET1]</sub>	MSZ-LN50VG2W- <sup>[E1]</sup> <sub>[ET1]</sub>	MSZ-LN60VG2W
MSZ-LN18VG2V- <sup>[E1]</sup> <sub>[ET1]</sub>	MSZ-LN25VG2V- <sup>[E1]</sup> <sub>[ET1]</sub>	MSZ-LN35VG2V- <sup>[E1]</sup> <sub>[ET1]</sub>	MSZ-LN50VG2V- <sup>[E1]</sup> <sub>[ET1]</sub>	MSZ-LN60VG2V
MSZ-LN18VG2B- <sup>[E1]</sup> <sub>[ET1]</sub>	MSZ-LN25VG2B- <sup>[E1]</sup> <sub>[ET1]</sub>	MSZ-LN35VG2B- <sup>[E1]</sup> <sub>[ET1]</sub>	MSZ-LN50VG2B- <sup>[E1]</sup> <sub>[ET1]</sub>	MSZ-LN60VG2B
MSZ-LN18VG2R- <sup>[E1]</sup> <sub>[ET1]</sub>	MSZ-LN25VG2R- <sup>[E1]</sup> <sub>[ET1]</sub>	MSZ-LN35VG2R- <sup>[E1]</sup> <sub>[ET1]</sub>	MSZ-LN50VG2R- <sup>[E1]</sup> <sub>[ET1]</sub>	MSZ-LN60VG2R

### WIRELESS REMOTE CONTROLLER





**NOTE:** Last setting will be stored after the unit is turned OFF with the remote controller. Indoor unit receives the signal of the remote controller with beeps.

### INDOOR UNIT DISPLAY SECTION

#### Operation Indicator lamp

The operation indicator at the right side of the indoor unit indicates the operation state.

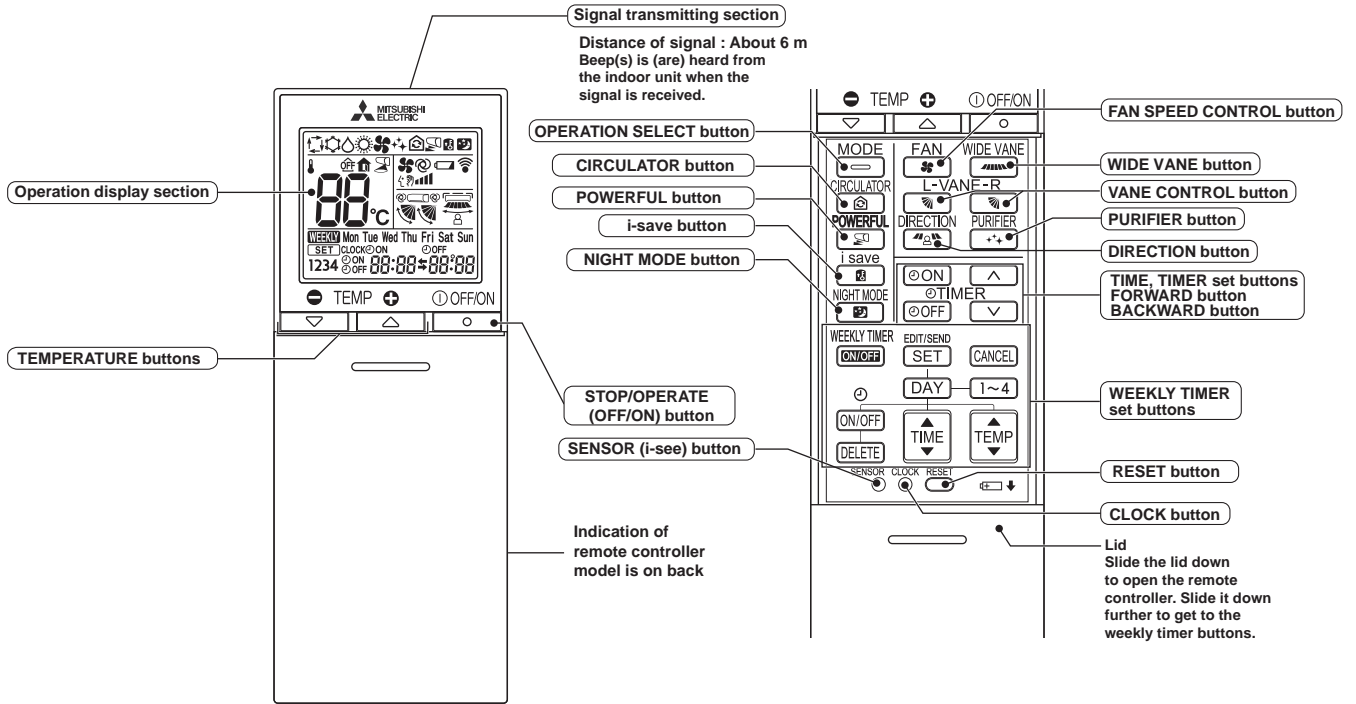
•The following indication applies regardless of shape of the indication.

Indication	Operation state	Room temperature
 	Standby mode (Only during multi system operation)	—

-  Lit
-  Blinking
-  Not lit

MSZ-LN18VG2W- [EN1] MSZ-LN25VG2W- [EN1] MSZ-LN35VG2W- [EN1] MSZ-LN50VG2W- [EN1]  
 MSZ-LN18VG2V- [EN1] MSZ-LN25VG2V- [EN1] MSZ-LN35VG2V- [EN1] MSZ-LN50VG2V- [EN1]  
 MSZ-LN18VG2B- [EN1] MSZ-LN25VG2B- [EN1] MSZ-LN35VG2B- [EN1] MSZ-LN50VG2B- [EN1]  
 MSZ-LN18VG2R- [EN1] MSZ-LN25VG2R- [EN1] MSZ-LN35VG2R- [EN1] MSZ-LN50VG2R- [EN1]

## WIRELESS REMOTE CONTROLLER





**NOTE:** Last setting will be stored after the unit is turned OFF with the remote controller. Indoor unit receives the signal of the remote controller with beeps.

## INDOOR UNIT DISPLAY SECTION

### Operation Indicator lamp

The operation indicator at the right side of the indoor unit indicates the operation state.

- The following indication applies regardless of shape of the indication.

Indication	Operation state	Room temperature
 	Standby mode (Only during multi system operation)	—

-  Lit
-  Blinking
-  Not lit

## 9-1. COOL (❄️) OPERATION

- (1) Press STOP/OPERATE (OFF/ON) button.

OPERATION INDICATOR lamp of the indoor unit turns on with a beep tone.

- (2) Select COOL mode with OPERATION SELECT button.

- (3) Press TEMPERATURE buttons TEMP  $\ominus$  or  $\oplus$  button to select the desired temperature. The setting range is 16 - 31°C.

### 1. Coil frost prevention

The compressor operational frequency is controlled by the temperature of the indoor heat exchanger to prevent the coil from frosting.

When the temperature of indoor heat exchanger becomes too low, the coil frost prevention mode works.

The indoor fan operates at the set speed and the compressor stops. This mode continues until the temperature of indoor heat exchanger rises.

### 2. Low outside temperature operation

When the outside temperature is lower, low outside temperature operation starts, and the outdoor fan slows or stops.

### 3. Indoor fan speed control

When the thermostat turns OFF, the indoor fan operates very Low to reduce power consumption.

When the room temperature rises and the thermostat is ON, the indoor fan operates according to the settings on the remote controller.

## 9-2. DRY (☀️) OPERATION

- (1) Press STOP/OPERATE (OFF/ON) button.

OPERATION INDICATOR lamp of the indoor unit turns on with a beep tone.

- (2) Select DRY mode with OPERATION SELECT button.

- (3) The set temperature is determined from the initial room temperature.

### 1. Coil frost prevention

Coil frost prevention works the same way as that in COOL mode. (9-1.1.)

### 2. Low outside temperature operation

Low outside temperature operation works the same way as that in COOL mode. (9-1.2.)

### 3. Indoor fan speed control

Indoor fan speed control works the same way as that in COOL mode. (9-1.3.)

## 9-3. FAN (🌀) OPERATION

- (1) OPERATION INDICATOR lamp of the indoor unit turns on with a beep tone.

- (2) Select FAN mode with OPERATION SELECT button.

- (3) Select the desired fan speed. When AUTO, it becomes Low.

Only indoor fan operates.

Outdoor unit does not operate.

## 9-4. HEAT (🔥) OPERATION

- (1) Press STOP/OPERATE (OFF/ON) button.

OPERATION INDICATOR lamp of the indoor unit turns on with a beep tone.

- (2) Select HEAT mode with OPERATION SELECT button.

- (3) Press TEMPERATURE buttons TEMP  $\ominus$  or  $\oplus$  button to select the desired temperature. The setting range is 10 - 31°C.

### 1. Cold air prevention control

When the compressor is not operating or is starting, and the temperature of indoor heat exchanger and/or the room temperature is low or when defrosting is being done, the indoor fan will stop or rotate in Very Low speed.

### 2. High pressure protection

The compressor operational frequency is controlled by the temperature of the indoor heat exchanger to prevent the condensing pressure from increasing excessively.

When the temperature of indoor heat exchanger becomes too high, the high pressure protection works.

The indoor fan operates following the cold air prevention control. This mode continues until the temperature of indoor heat exchanger falls.

### 3. Defrosting

Defrosting starts when the temperature of outdoor heat exchanger becomes too low.

The compressor stops once, the indoor/outdoor fans stop, the 4-way valve reverses, and the compressor re-starts.

This mode continues until the temperature of outdoor heat exchanger rises or the fixed time passes.

## 9-5. AUTO CHANGE OVER ... AUTO MODE OPERATION

Once desired temperature is set, unit operation is switched automatically between COOL and HEAT operation.

### Mode selection

- (1) Initial mode

When unit starts the operation with AUTO operation from OFF:

- If the room temperature is higher than the set temperature, operation starts in COOL mode.
- If the room temperature is equal to or lower than the set temperature, operation starts in HEAT mode.

- (2) Mode change

COOL mode changes to HEAT mode when about 15 minutes have passed with the room temperature 1°C below the set temperature.

HEAT mode changes to COOL mode when about 15 minutes have passed with the room temperature 1°C above the set temperature.

**NOTE 1:**

If 2 or more indoor units are operating in multi system, there might be a case that the indoor unit, which is operating in □ (AUTO), cannot change over to the other operating mode (COOL ↔ HEAT) and becomes a state of standby. Refer to **NOTE 2 “FOR MULTI SYSTEM AIR CONDITIONER”**.

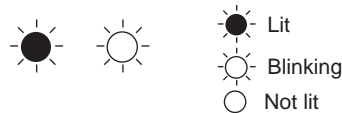
**NOTE 2:**

**FOR MULTI SYSTEM AIR CONDITIONER  
OUTDOOR UNIT: MXZ series**

Multi system air conditioner can connect 2 or more indoor units with one outdoor unit.

- When you try to operate 2 or more indoor units with one outdoor unit simultaneously, one for the cooling and the others for heating, the operation mode of the indoor unit that operates first is selected. Other indoor units cannot operate, and operation indicator lamp blinks as shown in the figure below. In this case, please set all the indoor units to the same operation mode.

**OPERATION INDICATOR**



- When indoor unit starts the operation while the defrosting of outdoor unit is being done, it takes a few minutes (max. 10 minutes) to blow out the warm air.
- In the heating operation, though indoor unit that does not operate may get warm or the sound of refrigerant flowing may be heard, they are not malfunction. The reason is that the refrigerant continuously flows into it.

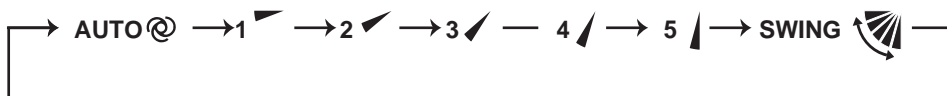
**9-6. AUTO VANE OPERATION**

**1. Horizontal vane**

(1) Vane motor drive

These models are equipped with stepping motors for the horizontal vanes. The rotating direction, speed, and angle of the motor are controlled by pulse signals (approximately 12 V) transmitted from indoor microprocessor.

(2) The horizontal vane angle and mode change as follows by pressing VANE CONTROL ( ) button.



**NOTE:** The right and left horizontal vanes set to the same level may not align perfectly.

(3) Positioning

To confirm the standard position, the vane moves until it touches the vane stopper. Then the vane is set to the selected angle.

Confirmation of standard position is performed in the following cases:

- (a) When the operation starts or finishes (including timer operation).
- (b) When the test run starts.
- (c) When standby mode (only during multi system operation) starts or finishes.

(4) VANE AUTO (@) mode

In VANE AUTO mode, the microprocessor automatically determines the vane angle to make the optimum room temperature distribution.

In COOL and DRY operation  
Vane angle is fixed to Horizontal position.



In HEAT operation  
Vane angle is fixed to Angle 4.



(5) STOP (operation OFF) and ON TIMER standby

In the following cases, the horizontal vane returns to the closed position.

- (a) When STOP/OPERATE (OFF/ON) button is pressed (POWER OFF).
- (b) When the operation is stopped by the emergency operation.
- (c) When ON TIMER is ON standby.

(6) Dew prevention

During COOL or DRY operation with the lower position when the compressor cumulative operation time exceeds 1 hour, the vane angle automatically changes to Angle 1 for dew prevention.

(7) SWING (🌀) mode

By selecting SWING mode with VANE CONTROL button, the horizontal vanes swing vertically.  
When COOL, DRY or FAN mode is selected, only the upper vane swings.

(8) Cold air prevention in HEAT operation

The horizontal vane position is set to Upward.

**NOTE:** When 2 or more indoor units are operated with multi outdoor unit, even if any indoor unit turns thermostat off, this control does not work in the indoor unit.

(9) ECONO COOL (🌀) operation (ECONOmical operation)

When ECONO COOL button is pressed in COOL mode, set temperature is automatically set 2°C higher by the microprocessor. However, the temperature on the LCD screen on the remote controller is not changed. Also the horizontal vane swings in various cycle.

SWING operation makes you feel cooler than set temperature. So, even though the set temperature is higher, the air conditioner can keep comfort. As a result, energy can be saved.

To cancel this operation, select a different mode or press one of the following buttons in ECONO COOL operation: ECONO COOL, VANE CONTROL, LONG or POWERFUL button.

(10) POWERFUL (🌀) operation

The air conditioner automatically adjusts the fan speed and the set temperature, and operates the POWERFUL mode. The POWERFUL mode is cancelled automatically 15 minutes after operation starts, or when POWERFUL button is pressed once again within 15 minutes after operation starts. The operation mode returns to the mode prior to POWERFUL operation. To cancel this operation manually, select a different mode or press one of the following buttons within 15 minutes after operation starts: STOP/OPERATE (OFF/ON), ECONO COOL, FAN SPEED CONTROL, CIRCULATOR, or i-save button.

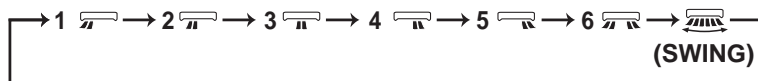
## 2. Vertical vane

(1) Vane motor drive

These models are equipped with a stepping motor for the vertical vane. The rotating direction, speed, and angle of the motor are controlled by pulse signals (approximately 12 V) transmitted from microprocessor.

(2) The vertical vane angle and mode change as follows by pressing WIDE VANE CONTROL button.

(3) Positioning



To confirm the standard position, the vane moves until it touches the vane stopper. Then the vane is set to the selected angle.

Confirmation of standard position is performed in the following cases:

(a) STOP/OPERATE (OFF/ON) button is pressed (POWER ON).

(4) SWING (🌀) MODE

By selecting SWING mode with WIDE VANE CONTROL button, the vertical vane swings horizontally. The remote controller displays "🌀". Swing mode is cancelled when WIDE MODE CONTROL button is pressed once again.

## 9-7. TIMER OPERATION

### 1. How to set the time

- (1) Check that the current time is set correctly.

**NOTE:** Timer operation will not work without setting the current time. Initially "0:00" blinks at the current time display of TIME MONITOR, so set the current time correctly with CLOCK button.

#### How to set the current time

- (a) Press the CLOCK button.  
 (b) Press the TIME SET buttons ( $\square\uparrow$ ) and ( $\square\downarrow$ ) to set the current time.
- Each time FORWARD button ( $\square\uparrow$ ) is pressed, the set time increases by 1 minute, and each time BACKWARD button ( $\square\downarrow$ ) is pressed, the set time decreases by 1 minute.
  - Pressing those buttons longer, the set time increases/decreases by 10 minutes.
- (c) Press the CLOCK set button.  
 (2) Press STOP/OPERATE (OFF/ON) button to start the air conditioner.  
 (3) Set the time of timer.

#### ON timer setting

- (a) Press ON TIMER button ( $\text{ON}$ ) during operation.  
 (b) Set the time of the timer using TIME SET buttons ( $\square\uparrow$ ) and ( $\square\downarrow$ ).

#### OFF timer setting

- (a) Press OFF TIMER button ( $\text{OFF}$ ) during operation.  
 (b) Set the time of the timer using TIME SET buttons ( $\square\uparrow$ ) and ( $\square\downarrow$ ).

\*Each time FORWARD button ( $\square\uparrow$ ) is pressed, the set time increases by 10 minutes: each time BACKWARD button ( $\square\downarrow$ ) is pressed, the set time decreases by 10 minutes.

### 2. To release the timer

To release ON timer, press ON TIMER button ( $\text{ON}$ ).

To release OFF timer, press OFF TIMER button ( $\text{OFF}$ ).

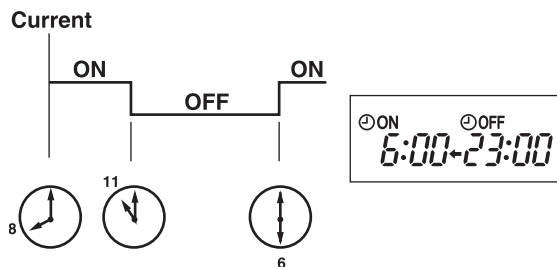
TIMER is cancelled and the display of set time disappears.

## PROGRAM TIMER

- OFF timer and ON timer can be used in combination. The set time that is reached first will operate first.
- "➔" and "➜" display shows the order of OFF timer and ON timer operation.

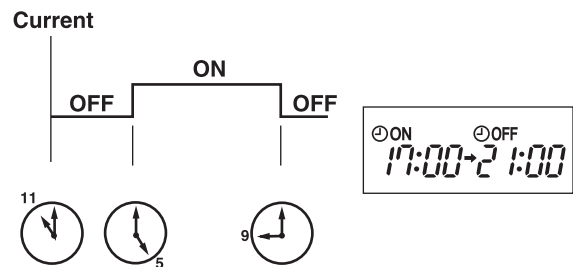
(Example 1) The current time is 8:00 PM.

The unit turns off at 11:00 PM, and on at 6:00 AM.



(Example 2) The current time is 11:00 AM.

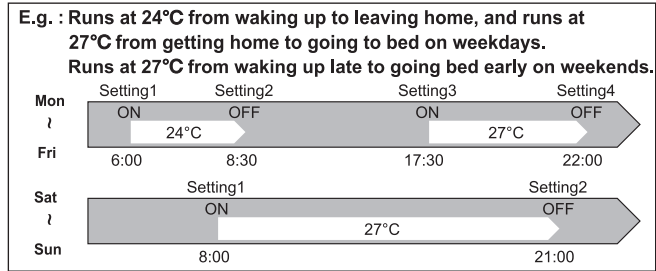
The unit turns on at 5:00 PM, and off at 9:00 PM.



**NOTE:** If the main power is turned OFF or a power failure occurs while ON/OFF timer is active, the timer setting is cancelled. As these models are equipped with an auto restart function, the air conditioner starts operating with timer cancelled when power is restored.

## 9-8. WEEKLY TIMER OPERATION

- A maximum of 4 ON or OFF timers can be set for individual days of the week.
- A maximum of 28 ON or OFF timers can be set for a week.



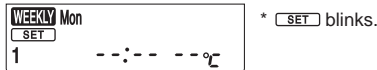
### NOTE:

- The simple ON/OFF timer setting is available while the weekly timer is on. In this case, the ON/OFF timer has priority over the weekly timer; the weekly timer operation will start again after the simple ON/OFF timer is complete.

### 1. How to set the weekly timer

\* Make sure that the current time and day are set correctly.

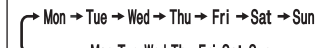
- (1) Press **EDIT/SEND** button to enter the weekly timer setting mode.



- (2) Press **DAY** and **1~4** buttons to select setting day and number.

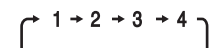


Pressing **DAY** selects the day of the week to be set.

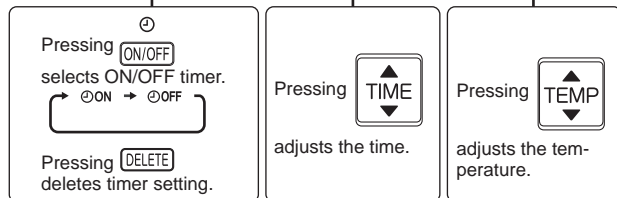


\* All days can be selected.

Pressing **1~4** selects the setting number.



- (3) Press **ON/OFF**, **TIME**, and **TEMP** buttons to set ON/OFF, time, and temperature.



\* Hold down the button to change the time quickly.

\* The temperature can be set between 16°C and 31°C at COOL operation.

\* The temperature can be set between 10°C and 31°C at HEAT operation.

Press **DAY** and **1~4** buttons to continue setting the timer for other days and/or numbers.



(4) Press button to complete and transmit the weekly timer setting.



\* which was blinking goes out, and the current time will be displayed.

**NOTE:**

- Press button to transmit the setting information of weekly timer to the indoor unit. Point the remote controller toward the indoor unit for 3 seconds.
- When setting the timer for more than one day of the week or one number, button does not have to be pressed per each setting. Press button once after all the settings are completed. All the weekly timer settings will be saved.
- Press button to enter the weekly timer setting mode, and press and hold button for 5 seconds to erase all weekly timer settings. Point the remote controller toward the indoor unit.

(5) Press button to turn the weekly timer ON. ( )

- When the weekly timer is ON, the day of the week whose timer setting is completed, will light.

Press button again to turn the weekly timer OFF. ( )

**NOTE:**

The saved settings will not be cleared when the weekly timer is turned OFF.

**2. Checking weekly timer setting**

(1) Press button to enter the weekly timer setting mode.

\* blinks.

(2) Press or buttons to view the setting of the particular day or number.

(3) Press button to exit the weekly timer setting.

**NOTE:**

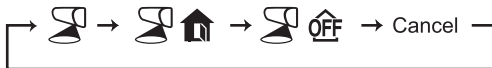
When all days of the week are selected to view the settings and a different setting is included among them, will be displayed.

**9-9. i-see CONTROL ( ) MODE AND ABSENCE DETECTION**

In the i-see control mode, the room temperature is controlled based on the sensible temperature.

(1) Press SENSOR button with a thin instrument during COOL, DRY, HEAT and AUTO mode to activate i-see control mode ( ).  
The default setting is “active”.

(2) Press SENSOR button several times to cancel i-see control mode.



**NOTE:**

How to detect human presence

- When the air conditioner starts to operate, the i-see Sensor analyzes the temperature of a room by rotating clockwise and counterclockwise.
- Then, it detects human presence by their motion based on their heat signatures.

Detection range

The i-see Sensor does not analyze the temperature in the following range.

- The wall surface on which the air conditioner is installed
- The spot beneath the air conditioner
- Where there is an object (such as furniture) between the place and the air conditioner

It might not detect human and objects properly on the following conditions

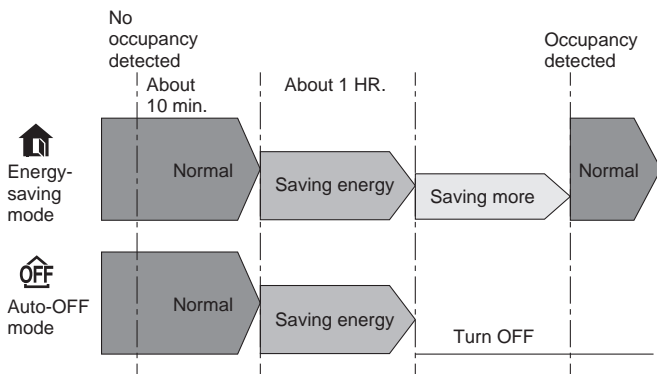
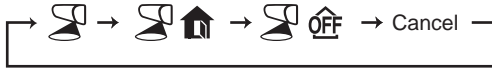
- When the temperature of the floor and the wall is high (such as when the air conditioner starts to operate in summer)
- When occupants are in blanket or wear heavily
- When there is an object whose temperature changes rapidly in a short time
- When windows and doors are small or they are far from the air conditioner
- When the sensor cannot detect the heat source such as of small kids or pets
- When using a floor heating or an electric carpet
- When occupants do not move after the air conditioner starts to operate

Refer to the following “Absence Detection” for and .

## ABSENCE DETECTION (🏠)

This function automatically changes the operation to No occupancy energy-saving mode or No occupancy Auto-OFF mode when nobody is in the room.

- (1) To activate this No occupancy energy-saving mode, press SENSOR button until 🏠 appears on the operation display of the remote controller.
- (2) To activate this No occupancy Auto-OFF mode, press SENSOR button until OFF appears on the operation display of the remote controller.
- (3) Press SENSOR button again to cancel the ABSENCE DETECTION.



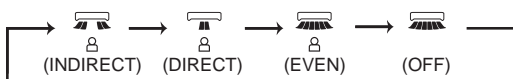
- Even if the unit is turned OFF due to No occupancy Auto-OFF mode, the display of the remote controller remains to indicate the unit is in operation. Press STOP/OPERATE(OFF/ON) button then press STOP/OPERATE(OFF/ON) button again to restart operation.
- When OFF timer is set, a priority is given to OFF timer.
- No occupancy energy saving mode or No occupancy Auto-OFF mode are not available during POWERFUL operation.
- The unit will not be turned off if no one is detected during normal operation mode, even though No occupancy Auto-OFF mode is activated.

## 9-10. AIRFLOW CONTROL MODE

AIRFLOW CONTROL mode offers air conditioning according to a location of an occupant in a room detected by i-see SENSOR.

- (1) Press DIRECTION button during COOL, DRY, HEAT or AUTO mode to activate the AIRFLOW CONTROL mode. This mode is only available when the i-see control mode is effective.

- (2) Each press of DIRECTION button changes AIRFLOW CONTROL in the following order:



(INDIRECT) : An occupant will be less exposed to direct airflow.

(DIRECT) : Mainly the vicinity of an occupant will be air-conditioned.

(EVEN) : The unit learns the area where an occupant spend most of the time, and evens out the temperature of that area.

### NOTE:

- Horizontal and vertical airflow directions will be automatically selected.
  - When more than a couple of people are in a room, the AIRFLOW CONTROL mode may work less effectively.
  - If you still feel uncomfortable with the air direction determined by the INDIRECT mode, adjust the air direction manually.
- (3) Cancelling the i-see control mode automatically cancels the AIRFLOW CONTROL mode.
    - The AIRFLOW CONTROL mode is also cancelled when the VANE CONTROL or WIDE VANE buttons is pressed.

## 9-11. NIGHT MODE (🌙) OPERATION

NIGHT MODE changes the brightness of the operation indicator, disables the beep sound and limits the noise level of the outdoor unit.

(1) Press NIGHT MODE button during operation to activate NIGHT mode (🌙).

- The operation indicator lamp dims.
- The beep sound will be disabled except that emitted when the operation is started or stopped.
- Noise level of the outdoor unit will be lower than that mentioned in SPECIFICATIONS.(Except the connection to MXZ.)

(2) Press NIGHT MODE button to cancel NIGHT mode (🌙).

### NOTE:

- Noise level of the outdoor unit may not change after startup of the unit, during the protection operation, or depending on other operating conditions.
- The fan speed of the indoor unit will not change.
- The operation indicator lamp will be hard to be seen in a bright room.
- Operating POWERFUL operation during NIGHT mode will increase the noise level of the outdoor unit.
- Noise level of the outdoor unit will not decrease during Multi system operation.

## 9-12. AIR PURIFYING (🌿) OPERATION

In the AIR PURIFYING operation, the indoor unit built-in device reduces airborne fungi, viruses, mold, and allergens.

(1) Press PURIFIER button to start AIR PURIFYING operation.

- AIR PURIFYING lamp turns on. (Display section)

(2) Press PURIFIER button again to cancel AIR PURIFYING operation.

- AIR PURIFYING lamp turns off. (Display section)

### NOTE:

- Never touch the air purifying device during operation. Although the air purifying device is safety-conscious design, touching this device could be the cause of trouble as this device discharge high voltage electricity.
- A "hissing" sound may be heard during the air purifying operation. This sound is produced when plasma is being discharged. This is not a malfunction.
- AIR PURIFYING lamp does not turn on if the front panel is not closed completely.

## 9-13. i-save (🔒) OPERATION

### 1. How to set i-save operation

(1) Press STOP/OPERATE (OFF/ON) button.

(2) Select COOL, CIRCULATOR, HEAT, ECONO COOL, or NIGHT mode.

(3) Press i-save button.

(4) Set the temperature, fan speed, and airflow direction for i-save operation.

### NOTE:

- i-save operation cannot be selected during DRY, FAN or AUTO mode operation.
- The setting range of HEAT mode i-save operation is 10 - 31°C.
- 2 groups of setting can be saved. (One for COOL/ECONO COOL/CIRCULATOR, one for HEAT)

### 2. How to cancel operation



- Press i-save button again.

- i-save operation can also be cancelled by pressing POWERFUL button or OPERATION SELECT button to change the operation mode.



The same setting is select from the next time by simply pressing i-save button.

### 9-14. OPERATION LOCK

This function locks operation mode only. Other functions, such as OFF/ON, temperature setting, or airflow direction adjustment, are available.

- (1) Hold down  button and  button simultaneously for 2 seconds while the unit is not operating to enable OPERATION LOCK.

The icon for the locked operation mode blinks.

- (2) Hold down  button and  button simultaneously for 2 seconds again while the unit is not operating to disable OPERATION LOCK.

- The icon for the locked operation mode blinks when  button and  button are held down to enable or disable OPERATION LOCK or  button is pressed during operation while OPERATION LOCK is enabled.
- AIR PURIFYING operation is not available when OPERATION LOCK is enabled in a mode other than FAN mode.

### 9-15. CIRCULATOR OPERATION

In case the indoor temperature reaches the setting temperature, the outdoor unit stops and the indoor unit starts FAN operation to circulate the indoor air.

The setting of fan speed and airflow direction can be changed.

The outdoor unit starts operation automatically when the indoor temperature drops below the setting temperature.

- (1) Press CIRCULATOR button during HEAT mode to enable CIRCULATOR operation.

The unit performs FAN operation in case the indoor temperature reaches the setting temperature.

- (2) Set the fan speed and airflow direction.

- The setting of fan speed and airflow direction is common for HEAT and CIRCULATOR operation.
- Ventilation starts at Low fan speed in case AUTO fan speed is selected.

- (3) Press CIRCULATOR button again to cancel CIRCULATOR operation.

#### NOTE:

CIRCULATOR operation doesn't work in the following situation.

- AUTO mode (Auto change over) is selected.
- Defrosting is being done.
- Indoor unit is connected to multi type outdoor unit.

Although received sound will be heard from the indoor unit and mark is displayed on remote controller when is pushed, CIRCULATOR operation doesn't work in multi connection.

- FAN operation may make you feel cold wind.

Reduce the FAN speed or adjust the airflow direction to avoid the wind.

### 9-16. EMERGENCY/TEST OPERATION

In the case of test run operation or emergency operation, use EMERGENCY OPERATION switch on the right side of the indoor unit. Emergency operation is available when the remote controller is missing or has failed, or when the batteries in the remote controller are running down. The unit will start and OPERATION INDICATOR lamp will light up. The first 30 minutes of operation is the test run operation. This operation is for servicing. The indoor fan runs at High speed and the temperature control does not work.

After 30 minutes of test run operation, the system shifts to EMERGENCY COOL/HEAT MODE with a set temperature of 24°C.

The fan speed shifts to Med.

The coil frost prevention works even in the test run or the emergency operation.

In the test run or emergency operation, the horizontal vane operates in VANE AUTO (@) mode.

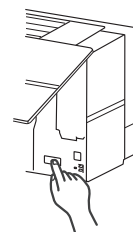
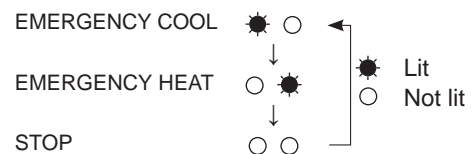
Emergency operation continues until EMERGENCY OPERATION switch is pressed once or twice or the unit receives any signal from the remote controller. In the latter case, normal operation will start.

**NOTE:** Do not press EMERGENCY OPERATION switch during normal operation.

Operation mode	COOL/HEAT
Set temperature	24°C
Fan speed	Med.
Horizontal vane	Auto

The operation mode is indicated by the Operation Indicator lamp as following

#### Operation Indicator lamp



Emergency operation switch (E.O. SW)

### 9-17. 3-MINUTE TIME DELAY OPERATION

When the system turns OFF, compressor will not restart for 3 minutes as 3-minute time delay function operates to protect compressor from overload.

MSZ-LN18VGW	MSZ-LN25VGW	MSZ-LN35VGW	MSZ-LN50VGW	MSZ-LN60VGW
MSZ-LN18VGV	MSZ-LN25VGV	MSZ-LN35VGV	MSZ-LN50VGV	MSZ-LN60VGV
MSZ-LN18VGB	MSZ-LN25VGB	MSZ-LN35VGB	MSZ-LN50VGB	MSZ-LN60VGB
MSZ-LN18VGR	MSZ-LN25VGR	MSZ-LN35VGR	MSZ-LN50VGR	MSZ-LN60VGR
MSZ-LN18VG2W	MSZ-LN25VG2W	MSZ-LN35VG2W	MSZ-LN50VG2W	MSZ-LN60VG2W
MSZ-LN18VG2V	MSZ-LN25VG2V	MSZ-LN35VG2V	MSZ-LN50VG2V	MSZ-LN60VG2V
MSZ-LN18VG2B	MSZ-LN25VG2B	MSZ-LN35VG2B	MSZ-LN50VG2B	MSZ-LN60VG2B
MSZ-LN18VG2R	MSZ-LN25VG2R	MSZ-LN35VG2R	MSZ-LN50VG2R	MSZ-LN60VG2R

### 10-1. CAUTIONS ON TROUBLESHOOTING

#### 1. Before troubleshooting, check the following

- 1) Check the power supply voltage.
- 2) Check the indoor/outdoor connecting wire for miswiring.

#### 2. Take care of the following during servicing

- 1) Before servicing the air conditioner, be sure to turn OFF the main unit first with the remote controller, and then after confirming the horizontal vane is closed, turn OFF the breaker and/or disconnect the power plug.
- 2) Be sure to turn OFF the power supply before removing the front panel, the cabinet, the top panel, and the P.C. board.
- 3) When removing the P.C. board, hold the edge of the board with care NOT to apply stress on the components.
- 4) When connecting or disconnecting the connectors, hold the connector housing. DO NOT pull the lead wires.

<Incorrect>



Lead wiring

<Correct>



Connector housing

#### 3. Troubleshooting procedure

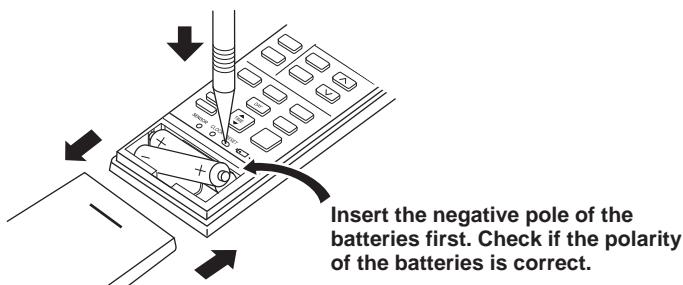
- 1) Check if the OPERATION INDICATOR lamp on the indoor unit is blinking ON and OFF to indicate an abnormality. To make sure, check how many times the OPERATION INDICATOR lamp is blinking ON and OFF before starting service work.
- 2) Before servicing, check that the connector and terminal are connected properly.
- 3) When the electronic control P.C. board seems to be defective, check the copper foil pattern for disconnection and the components for bursting and discoloration.
- 4) When troubleshooting, Refer to 10-2, 10-3 and 10-4.

#### 4. How to replace batteries

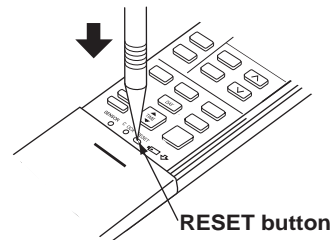
Weak batteries may cause the remote controller malfunction.

In this case, replace the batteries to operate the remote controller normally.

- ① Remove the front lid and insert batteries. Then reattach the front lid.



- ② Press RESET button with a thin instrument, and then use the remote controller.



**NOTE:** 1. If RESET button is not pressed, the remote controller may not operate correctly.

2. This remote controller has a circuit to automatically reset the microcomputer when batteries are replaced. This function is equipped to prevent the microcomputer from malfunctioning due to the voltage drop caused by the battery replacement.
3. Do not use the leaking batteries.

## 10-2. FAILURE MODE RECALL FUNCTION

### Outline of the function

This air conditioner can memorize the abnormal condition which has occurred once.

Even though LED indication listed on the troubleshooting check table (10-4.) disappears, the memorized failure details can be recalled.

### 1. Flow chart of failure mode recall function for the indoor/outdoor unit

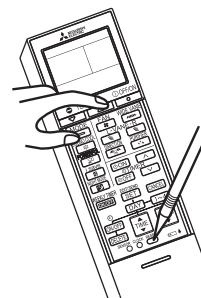
**NOTE:** The indoor unit does not operate by smartphone, refer to 10-3.2."Check of Wi-Fi Interface".

#### Operational procedure

The cause of abnormality cannot be found because the abnormality does not recur.

#### Setting up the failure mode recall function

Turn ON the power supply.  
 <Preparation of the remote controller>  
 ① While pressing both OPERATION SELECT button and TEMP  $\oplus$  button on the remote controller at the same time, press RESET button.  
 ② First, release RESET button.  
 Hold down the other two buttons for another 3 seconds. Make sure that the indicators on the LCD screen shown in the right figure are all displayed. Then release the buttons.  
 ③ The set temperature is displayed to 24°C.



Press STOP/OPERATE (OFF/ON) button of the remote controller (the set temperature is displayed) with the remote controller headed towards the indoor unit. \*1

\*1 Regardless of normal or abnormal condition, a short beep is emitted once the signal is received.

Does POWER lamp on the indoor unit blink at the interval of 0.5 seconds?  
 Blinks: Either indoor or outdoor unit is abnormal.  
 Beep is emitted at the same timing as the blinking of POWER lamp.\*2

Indoor unit is normal.  
 But the outdoor unit might be abnormal because there are some abnormalities that cannot be recalled with this way.  
 Check if outdoor unit is abnormal according to the detailed outdoor unit failure mode recall function.

#### Judgment of indoor/outdoor abnormality

Before blinking, does POWER lamp stay ON for 3 seconds?  
 When it stays ON for 3 seconds (without beep):  
 The outdoor unit is abnormal.

**NOTE:** It takes up to 1 minute to indicate the outdoor unit abnormality. Even if the OPERATION INDICATOR lamp is not lit, keep checking at least 1 minute or longer.

The indoor unit is abnormal.  
 Check the blinking pattern, and identify the abnormal point by referring to the table of indoor unit failure mode recall function. (Refer to 10-2.4)  
 Make sure to check at least 2 consecutive blinking cycles.\*2

The outdoor unit is abnormal.  
 Check the blinking pattern, and identify the abnormal point by referring to the table of outdoor unit failure mode recall function. (Refer to outdoor unit service manual.)  
 Make sure to check at least 2 consecutive blinking cycles.\*3

#### Releasing the failure mode recall function

Release the failure mode recall function by the following procedures.  
 Turn OFF the power supply and turn it ON again.  
 Press RESET button of the remote controller.

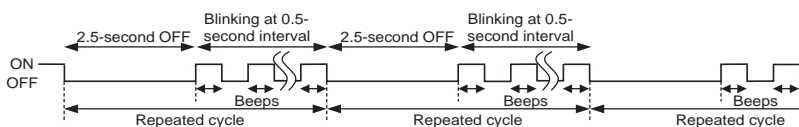
Repair the failure parts.

#### Deleting the memorized abnormal condition

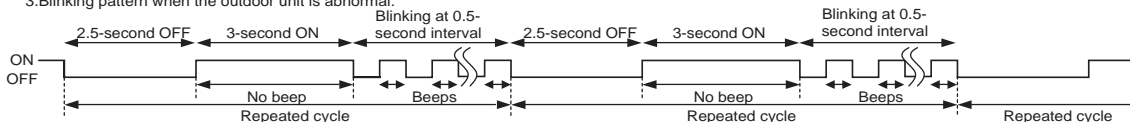
- ① After repairing the unit, recall the failure mode again according to "Setting up the failure mode recall function" mentioned above.
- ② Press STOP/OPERATE (OFF/ON) button of the remote controller (the set temperature is displayed) with the remote controller headed towards the indoor unit.
- ③ Press EMERGENCY OPERATION switch so that the memorized abnormal condition is deleted. \*4
- ④ Release the failure mode recall function according to "Releasing the failure mode recall function" mentioned above.

**NOTE:** 1. Make sure to release the failure mode recall function after it is set up, otherwise the unit cannot operate properly.  
 2. If the abnormal condition is not deleted from the memory, the last abnormal condition is kept memorized.

\*2. Blinking pattern when the indoor unit is abnormal:



\*3. Blinking pattern when the outdoor unit is abnormal:

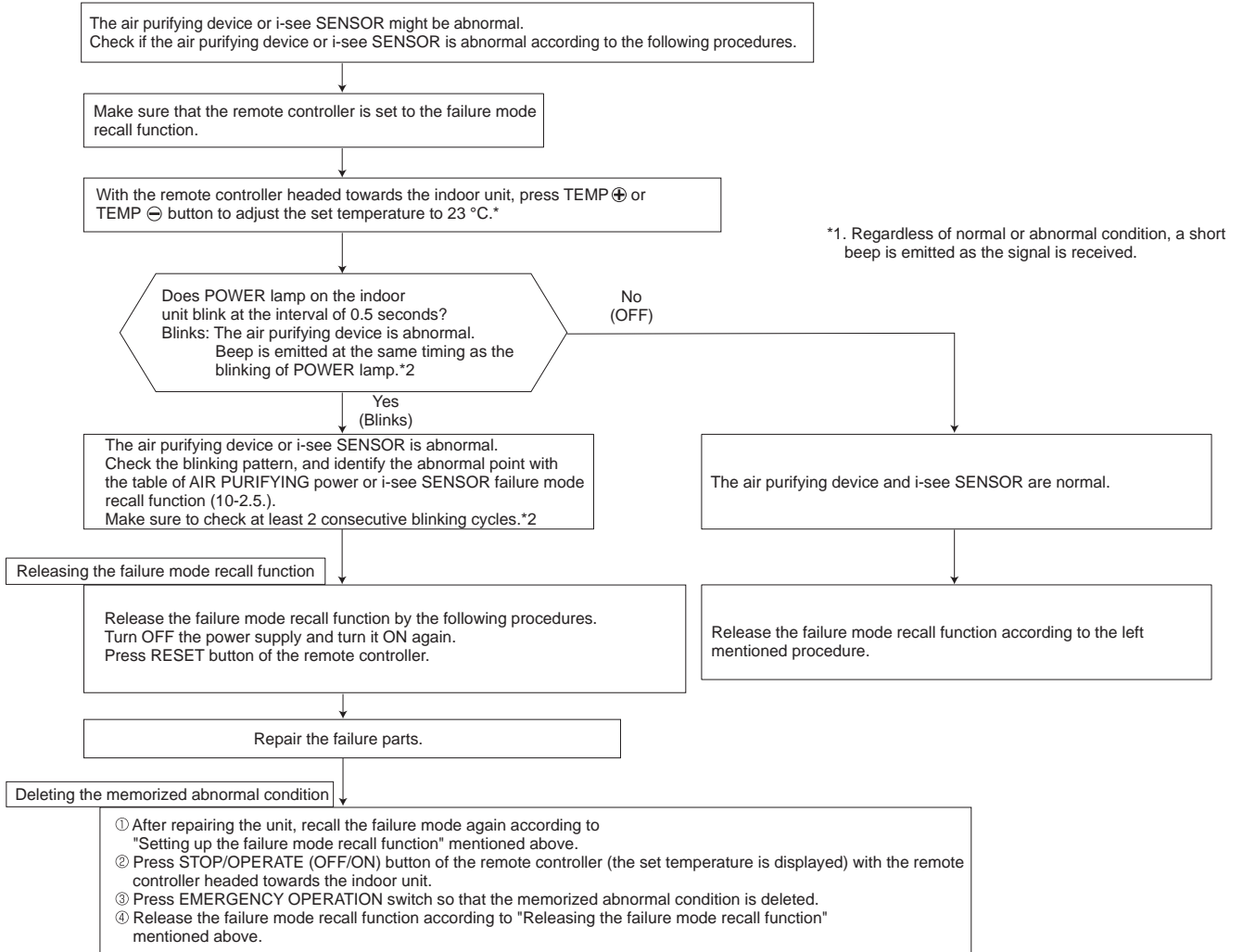


\*4 The information regarding whether the connected outdoor unit is a low-standby-power model or a non-low-standby-power model will also be initialized. (Default= compatible with a low-standby-power model)



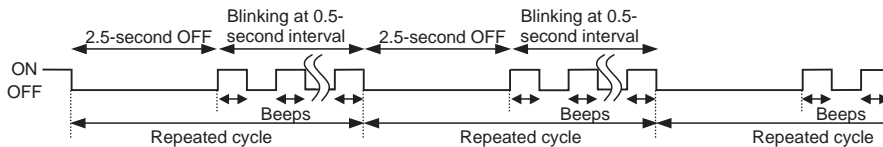
## 2. Flow chart of AIR PURIFYING power failure mode and i-see SENSOR failure mode recall function

Operational procedure



Note1. Make sure to release the failure mode recall function after it is set up, otherwise the unit cannot operate properly.  
2. If the abnormal condition is not deleted from the memory, the last abnormal condition is kept memorized.

\*2. Blinking pattern when the air purifying device is abnormal:



## 3. AIR PURIFYING power operation check

AIR PURIFYING power goes ON when PURIFIER button on the remote controller is pressed with any set temperature displayed during failure mode recall function. Check the operation display section of the remote controller to confirm that AIR PURIFYING power is activated. While AIR PURIFYING lamp stays OFF, it means normal. Blinking AIR PURIFYING lamp means abnormal, the AIR PURIFYING power is not conducted.

AIR PURIFYING lamp	Remedy
Continuously blinking	Follow "Check of AIR PURIFYING power" to identify the error. (Refer to 10-6.Ⓔ.)
2-time blink	AIR PURIFYING power control circuit on the indoor electronic control P.C. board is out of order. (Refer to 10-6.Ⓔ.)

**NOTE:** Perform the above mentioned check with the front panel closed. The interlock switch (Air purifying device) works by opening front panel and the AIR PURIFYING power is cut.



#### 4. Table of indoor unit failure mode recall function (When recalled at a set temperature of 24°C)

POWER lamp	Abnormal point (Failure mode)	Condition	Remedy
Not lit	Normal	—	—
1-time blink every 0.5-second	Room temperature thermistor	The room temperature thermistor short or open circuit is detected every 8 seconds during operation.	Refer to the characteristics of the room temperature thermistor (10-7.).
2-time blink 2.5-second OFF	Indoor coil thermistor	The indoor coil thermistor short or open circuit is detected every 8 seconds during operation.	Refer to the characteristics of the main indoor coil thermistor, the sub indoor coil thermistor (10-7.).
3-time blink 2.5-second OFF	Serial signal	The serial signal from outdoor unit is not received for a maximum of 6 minutes.	Refer to 10-6.Ⓞ "How to check miswiring and serial signal error".
11-time blink 2.5-second OFF	Indoor fan motor	The rotational frequency feedback signal is not emitted for 12 seconds after the indoor fan motor is operated	Refer to 10-6.Ⓐ "Check of indoor fan motor".
12-time blink 2.5-second OFF	Indoor control system	It cannot properly read data in the nonvolatile memory of the indoor electronic control P.C. board.	Replace the indoor electronic control P.C. board.

**NOTE:** Blinking patterns of this mode differ from the ones of TROUBLESHOOTING CHECK TABLE (10-4.).

#### 5. Table of indoor unit failure mode recall function (When recalled at a set temperature of 23°C)

##### Table of AIR PURIFYING power failure mode recall function

POWER lamp	Abnormal point (Failure mode)	Condition	Remedy
1-time blink	AIR PURIFYING power control	When AIR PURIFYING power cannot be turned OFF even if the AIR PURIFYING operation is turned OFF with the remote controller.	Refer to 10-6. Ⓞ "Check of AIR PURIFYING power".
2-time blink	Electrode (Spark discharge)	When the voltage between CN1T1 Ⓜ (+) and Ⓜ (GND) on the electronic P.C. board falls below 1.3V (spark discharge judgment voltage).	
3-time blink	Electrode (Abnormal electric discharge error 1)	When the voltage between CN1T1 Ⓜ (+) and Ⓜ (GND) on the electronic P.C. board falls by 1.2V below the normal voltage value (2.5V).	
4-time blink	Electrode (Abnormal electric discharge error 2)	When the voltage between CN1T1 Ⓜ (+) and Ⓜ (GND) on the electronic P.C. board falls significantly. (0.4V / 0.5ms)	
5-time blink	AIR PURIFYING power	When the voltage between CN1T1 Ⓜ (+) and Ⓜ (GND) on the electronic P.C. board rises above 3V.	

**NOTE1 :** Blinking patterns of this mode differ from the ones of TROUBLESHOOTING CHECK TABLE (10-4.).

**NOTE2 :** As soon as an abnormality is detected, AIR PURIFYING power goes OFF, therefore measuring instrument which records the voltage wave is required in order to perform the above mentioned voltage measurement.

##### Table of i-see SENSOR failure mode recall function

POWER lamp	Abnormal point (Failure mode)	Condition	Remedy
6-time blink	i-see SENSOR	Poor contact in i-see SENSOR wiring Failure in loading corrected data of i-see SENSOR	Check for disconnection of the connectors.

**NOTE:** Blinking patterns of this mode differ from the ones of TROUBLESHOOTING CHECK TABLE (10-4.).

#### 6. Operation check on i-see SENSOR

While recalling the failure details, set the temperature to 19°C to perform the simple check on the i-see SENSOR.

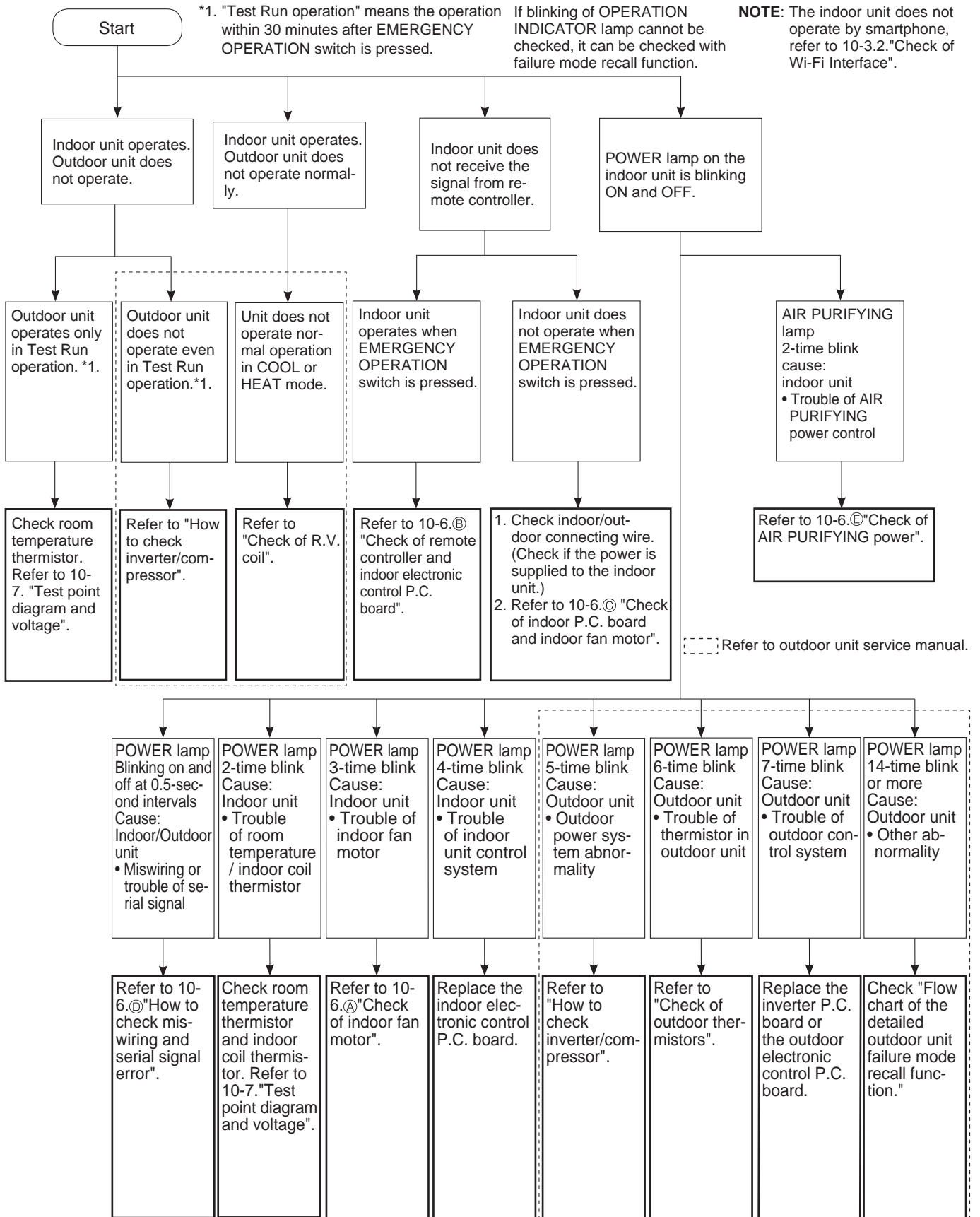
Place your hand over the i-see SENSOR, and the buzzer will beep at 1 second intervals. (Normal detection temperature range is 34 to 39°C.)

If the buzzer does not beep, check for disconnection of the connectors.

Set the temperature to 24°C to exit the simple check mode on the i-see SENSOR.

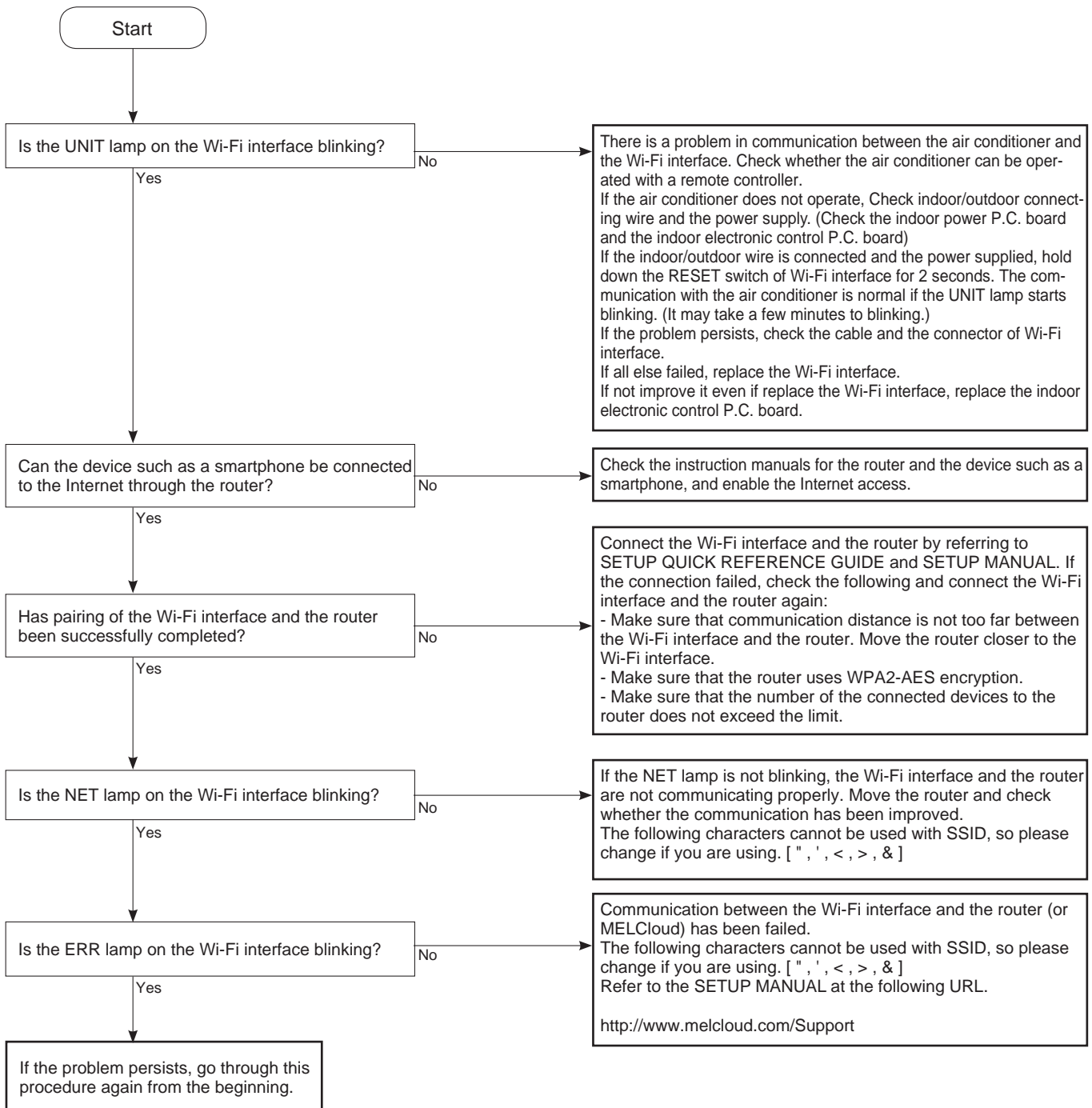
### 10-3. INSTRUCTION OF TROUBLESHOOTING

#### 1. Check of the unit.



## 2. Check of Wi-Fi interface

Follow the procedure below if the air conditioner cannot be monitored or controlled with a device such as a smartphone.



## 10-4. TROUBLESHOOTING CHECK TABLE

Before taking measures, make sure that the symptom reappears for accurate troubleshooting.

When the indoor unit has started operation and detected an abnormality of the following condition (the first detection after the power ON), the indoor fan motor turns OFF and OPERATION INDICATOR lamp blinks.

- The following indicator applies regardless of shape of the indication.

OPERATION INDICATOR



No.	Abnormal point	Operation indicator lamp	Symptom	Condition	Remedy
1	Miswiring or serial signal	POWER lamp blinks. 0.5-second ON ●○●○●○●○ 0.5-second OFF	Indoor unit and outdoor unit do not operate.	The serial signal from the outdoor unit is not received for 6 minutes. The indoor unit is connected to a low-standby-power model after once connected to a non-low-standby-power model.	<ul style="list-style-type: none"> <li>• Refer to 10-6. ⑩ "How to check miswiring and serial signal error".</li> <li>• Refer to <b>NOTE</b>.</li> </ul>
2	Indoor coil thermistor Room temperature thermistor	POWER lamp blinks. 2-time blink ●○●○○○○○●○●○ 2.5-second OFF		The indoor coil or the room temperature thermistor is short or open circuit.	<ul style="list-style-type: none"> <li>• Refer to the characteristics of indoor coil thermistor, and the room temperature thermistor (10-7.).</li> </ul>
3	Indoor fan motor	POWER lamp blinks. 3-time blink ●○●○●○○○○○●○●○●○ 2.5-second OFF		The rotational frequency feedback signal is not emitted during the indoor fan operation.	<ul style="list-style-type: none"> <li>• Refer to 10-6. ⑪ "Check of indoor fan motor".</li> </ul>
4	Indoor control system	POWER lamp blinks. 4-time blink ●○●○●○●○○○○○●○●○●○●○ 2.5-second OFF		It cannot properly read data in the nonvolatile memory of the indoor electronic control P.C. board.	<ul style="list-style-type: none"> <li>• Replace the indoor electronic control P.C. board.</li> </ul>
5	Outdoor power system	POWER lamp blinks. 5-time blink ●○●○●○●○●○○○○○●○●○●○ 2.5-second OFF		It consecutively occurs 3 times that the compressor stops for overcurrent protection or startup failure protection within 1 minute after startup.	<ul style="list-style-type: none"> <li>• Refer to "How to check of inverter/compressor".</li> <li>• Refer to outdoor unit service manual</li> <li>• Check the stop valve.</li> </ul>
6	Outdoor thermistors	POWER lamp blinks. 6-time blink ●○●○●○●○●○●○○○○○●○●○ 2.5-second OFF		The outdoor thermistors short or open circuit during the compressor operation.	<ul style="list-style-type: none"> <li>• Refer to "Check of outdoor thermistor".</li> <li>• Refer to outdoor unit service manual.</li> </ul>
7	Outdoor control system	POWER lamp blinks. 7-time blink ●○●○●○●○●○●○●○○○○○●○●○ 2.5-second OFF		It cannot properly read data in the nonvolatile memory of the inverter P.C. board or the outdoor electronic control P.C. board.	<ul style="list-style-type: none"> <li>• Replace the inverter P.C. board or the outdoor electronic control P.C. board.</li> <li>• Refer to outdoor unit service manual.</li> </ul>
8	Other abnormality	POWER lamp blinks. 14-time blink or more ●○●○●○●○●○●○●○●○●○●○●○●○●○ 2.5-second OFF		An abnormality other than above mentioned is detected.	<ul style="list-style-type: none"> <li>• Check the stop valve.</li> <li>• Check the 4-way valve.</li> <li>• Check the abnormality in detail using the failure mode recall function for outdoor unit.</li> </ul>
9	Outdoor control system	POWER lamp lights up. ●		Outdoor unit does not operate	It cannot properly read data in the nonvolatile memory of the inverter P.C. board or the outdoor electronic control P.C. board.

**NOTE:** The indoor unit may have been connected to a non-low-standby-power model outdoor unit. To use a low-standby-power model, clear the error history by referring to "Deleting the memorized abnormal condition" described in 10-2.1. When the error history is being cleared, the connection information also will be initialized. The indoor unit will be compatible with a low-standby-power model after initialization. If the operation indicator lamp continues to blink as shown in No.1 after the procedure, refer to 10-6. ⑩ "How to check miswiring and serial error".

OPERATION INDICATOR      ● Lit  
 (POWER)      (AIR PURIFYING)      ◐ Blinking  
    ○ Not lit

No.	Abnormal point	Operation indicator lamp	Symptom	Condition	Remedy
1	MXZ type Operation mode setting	<ul style="list-style-type: none"> <li>AIR PURIFYING lamp blink.</li> </ul> <ul style="list-style-type: none"> <li>POWER lamp is lit.</li> </ul>	Outdoor unit operates but indoor unit does not operate.	The operation mode of the each indoor unit is differently set to COOL (includes DRY, FAN) and HEAT at the same time, the operation mode of the indoor unit that has operated at first has the priority.	<ul style="list-style-type: none"> <li>Unify the operation mode. Refer to outdoor unit service manual.</li> </ul>

OPERATION INDICATOR      ● Lit  
 (POWER)      (AIR PURIFYING)      ◐ Blinking  
    ○ Not lit

No.	Abnormal point	Operation indicator lamp	Symptom	Condition	Remedy
1	AIR PURIFYING power control	<ul style="list-style-type: none"> <li>AIR PURIFYING lamp blinks.</li> </ul>	Indoor unit and outdoor unit do not operate.	When AIR PURIFYING power cannot be turned OFF even if the AIR PURIFYING operation is turned OFF by remote controller.	<ul style="list-style-type: none"> <li>Refer to 10-6.㉔ "Check of AIR PURIFYING power".</li> </ul>

**10-5. TROUBLE CRITERION OF MAIN PARTS**

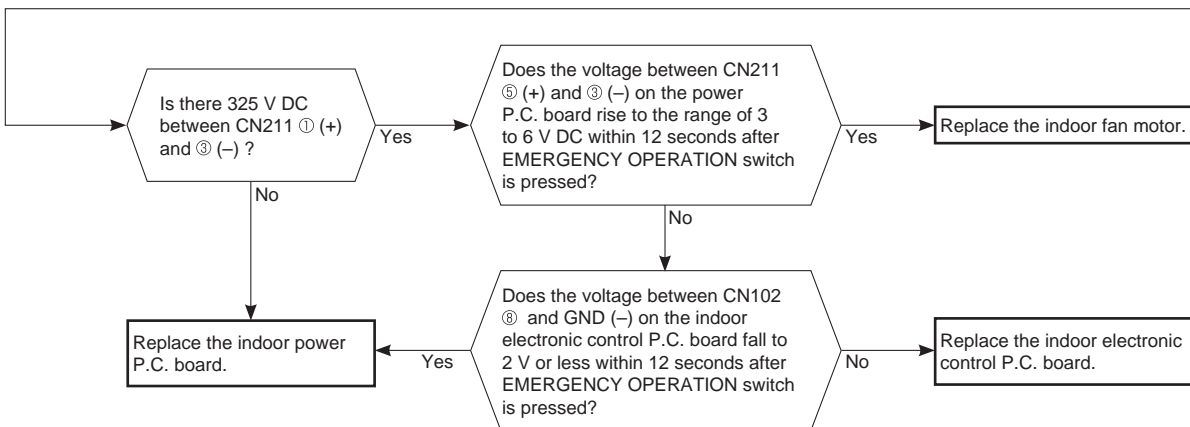
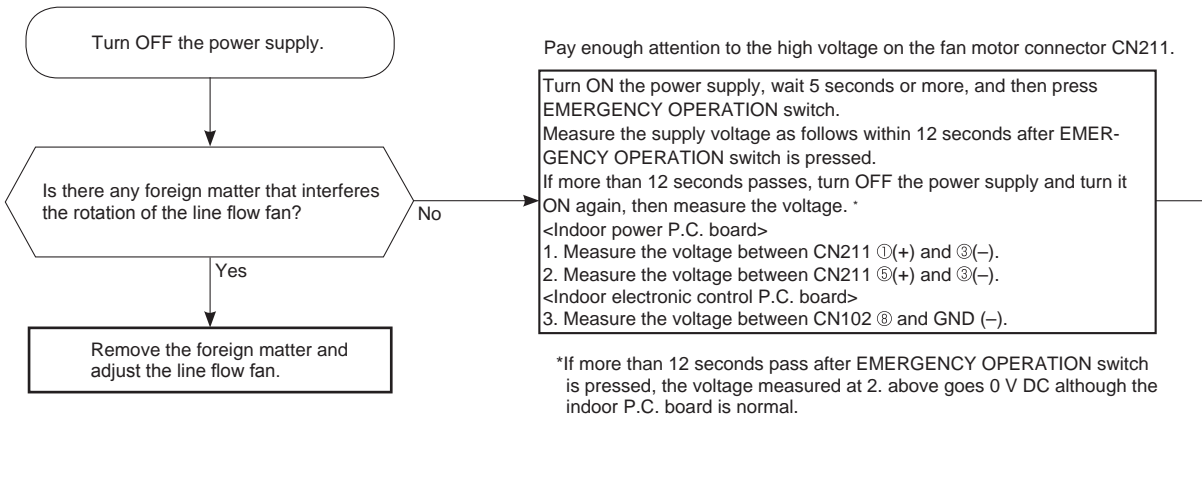
- |                     |                     |                     |                     |                     |
|---------------------|---------------------|---------------------|---------------------|---------------------|
| <b>MSZ-LN18VGW</b>  | <b>MSZ-LN25VGW</b>  | <b>MSZ-LN35VGW</b>  | <b>MSZ-LN50VGW</b>  | <b>MSZ-LN60VGW</b>  |
| <b>MSZ-LN18VGV</b>  | <b>MSZ-LN25VGV</b>  | <b>MSZ-LN35VGV</b>  | <b>MSZ-LN50VGV</b>  | <b>MSZ-LN60VGV</b>  |
| <b>MSZ-LN18VGB</b>  | <b>MSZ-LN25VGB</b>  | <b>MSZ-LN35VGB</b>  | <b>MSZ-LN50VGB</b>  | <b>MSZ-LN60VGB</b>  |
| <b>MSZ-LN18VGR</b>  | <b>MSZ-LN25VGR</b>  | <b>MSZ-LN35VGR</b>  | <b>MSZ-LN50VGR</b>  | <b>MSZ-LN60VGR</b>  |
| <b>MSZ-LN18VG2W</b> | <b>MSZ-LN25VG2W</b> | <b>MSZ-LN35VG2W</b> | <b>MSZ-LN50VG2W</b> | <b>MSZ-LN60VG2W</b> |
| <b>MSZ-LN18VG2V</b> | <b>MSZ-LN25VG2V</b> | <b>MSZ-LN35VG2V</b> | <b>MSZ-LN50VG2V</b> | <b>MSZ-LN60VG2V</b> |
| <b>MSZ-LN18VG2B</b> | <b>MSZ-LN25VG2B</b> | <b>MSZ-LN35VG2B</b> | <b>MSZ-LN50VG2B</b> | <b>MSZ-LN60VG2B</b> |
| <b>MSZ-LN18VG2R</b> | <b>MSZ-LN25VG2R</b> | <b>MSZ-LN35VG2R</b> | <b>MSZ-LN50VG2R</b> | <b>MSZ-LN60VG2R</b> |

Part name	Check method and criterion	Figure				
Room temperature thermistor (RT11) Indoor coil thermistor (RT12, RT13)	Measure the resistance with a tester.  Refer to 10-7. "Test point diagram and voltage", "Indoor electronic control P.C. board", for the chart of thermistor.					
Indoor fan motor (MF)	Check 10-6.㉓ "Check of indoor fan motor".					
Vane motor (MV1) (HORIZONTAL)	Measure the resistance between the terminals with a tester. (Temperature: 10 - 30°C)					
	<table border="1"> <tr> <td>Color of the lead wire</td> <td>Normal</td> </tr> <tr> <td>RED - SKY</td> <td>262 - 328 Ω</td> </tr> </table>	Color of the lead wire	Normal	RED - SKY	262 - 328 Ω	
Color of the lead wire	Normal					
RED - SKY	262 - 328 Ω					
Vane motor (MV2) (VERTICAL)	Measure the resistance between the terminals with a tester. (Temperature: 10 - 30°C)					
	<table border="1"> <tr> <td>Color of the lead wire</td> <td>Normal</td> </tr> <tr> <td>RED - SKY</td> <td>219 - 273 Ω</td> </tr> </table>	Color of the lead wire	Normal	RED - SKY	219 - 273 Ω	
Color of the lead wire	Normal					
RED - SKY	219 - 273 Ω					
i-see SENSOR MOTOR (MT)	Measure the resistance between the terminals with a tester. (Temperature: 10 - 30°C)					
	<table border="1"> <tr> <td>Color of the lead wire</td> <td>Normal</td> </tr> <tr> <td>RED - BLK</td> <td>262 - 328 Ω</td> </tr> </table>	Color of the lead wire	Normal	RED - BLK	262 - 328 Ω	
Color of the lead wire	Normal					
RED - BLK	262 - 328 Ω					
AIR PURIFYING power	Check 10-6.㉔.					

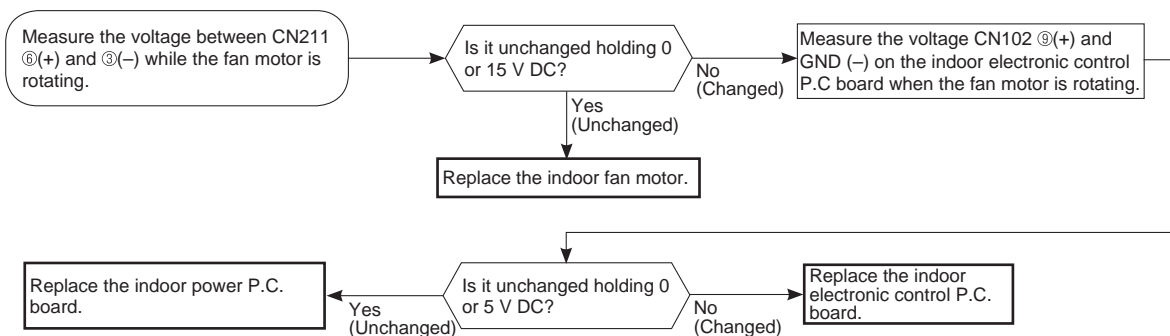
## 10-6. TROUBLESHOOTING FLOW

### A Check of indoor fan motor

The indoor fan motor error has occurred, and the indoor fan does not operate.

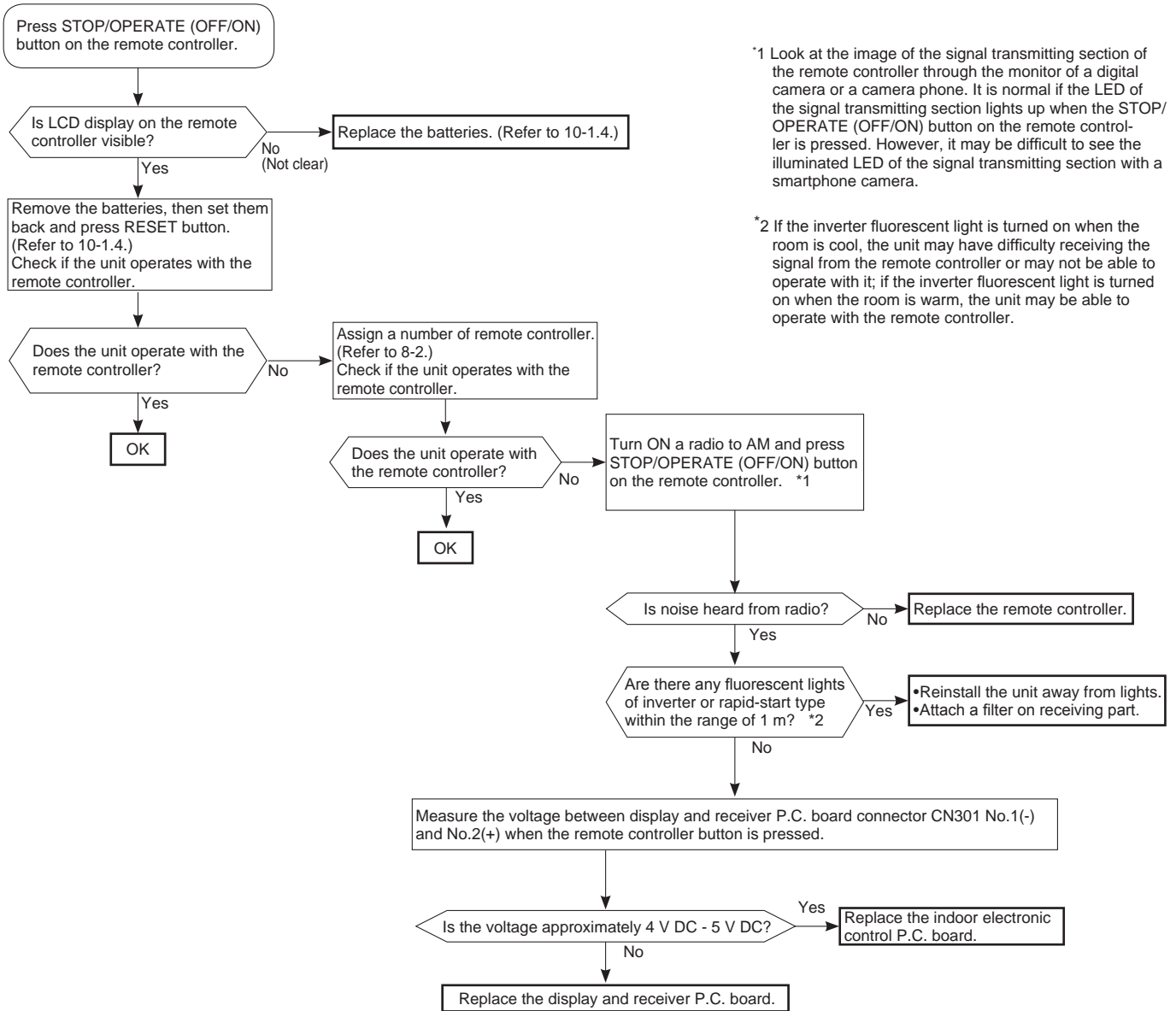


The indoor fan motor error has occurred, and the indoor fan repeats "12-second ON and 30-second OFF" 3 times, and then stops.



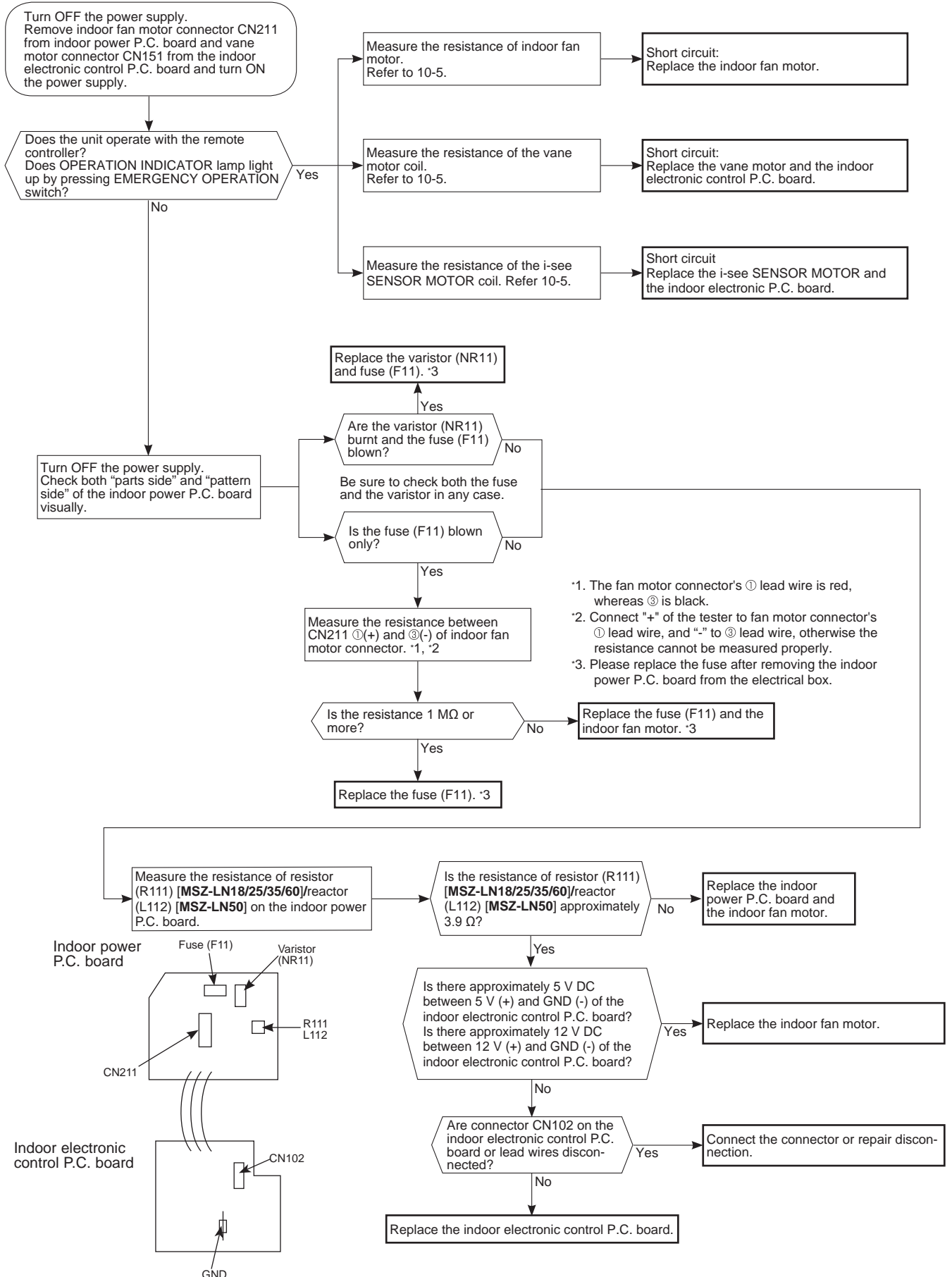
## B Check of remote controller and indoor electronic control P.C. board

**NOTE:** Check if the remote controller is exclusive for this air conditioner.



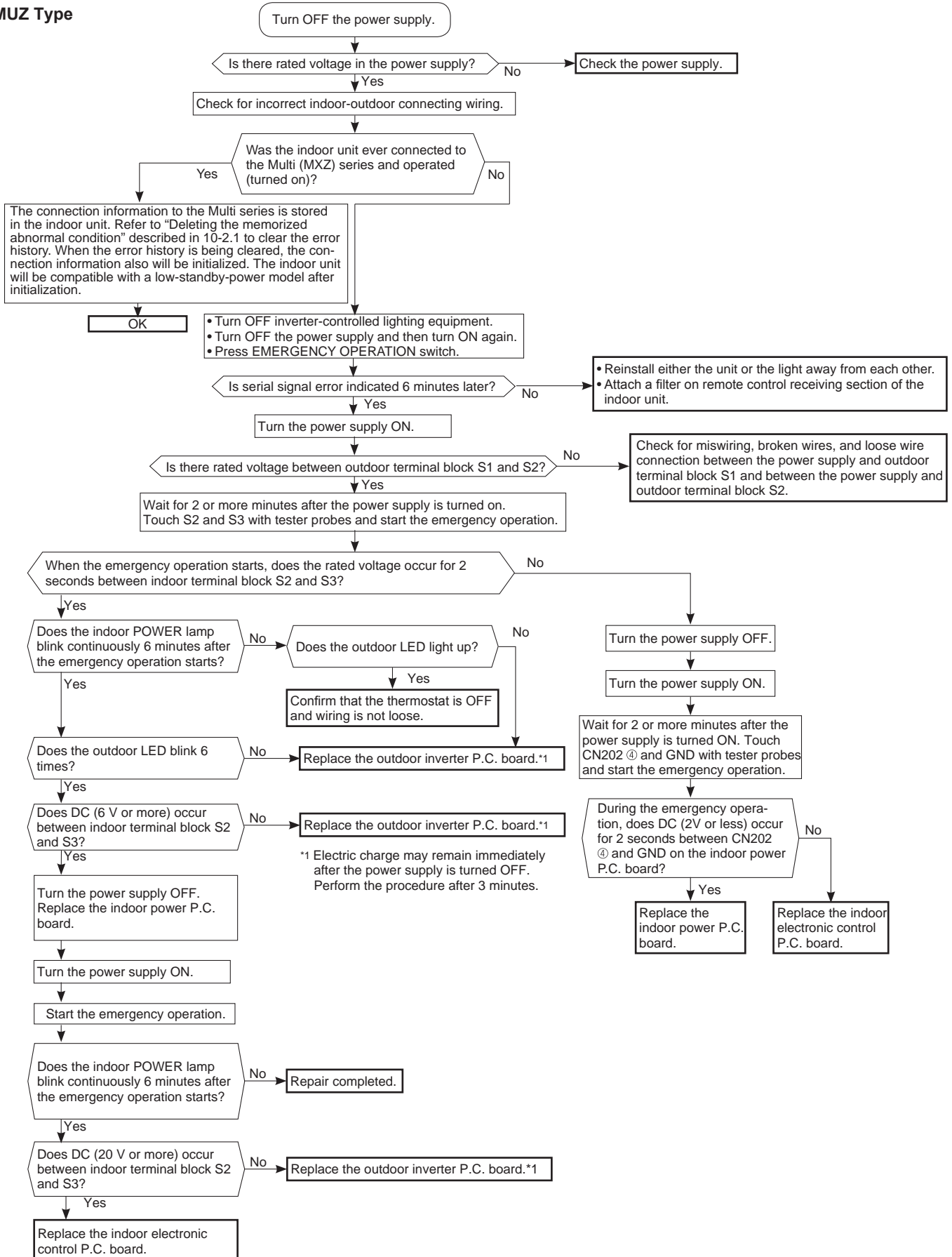


## © Check of indoor P.C. board and indoor fan motor



## D How to check miswiring and serial signal error

MUZ Type



## MXZ Type

### LED indication

#### for communication status

Communication status is indicated by the LED.

#### Unit status

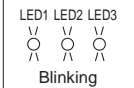
Blinking: Normal communication

Lit: Abnormal communication or not connected

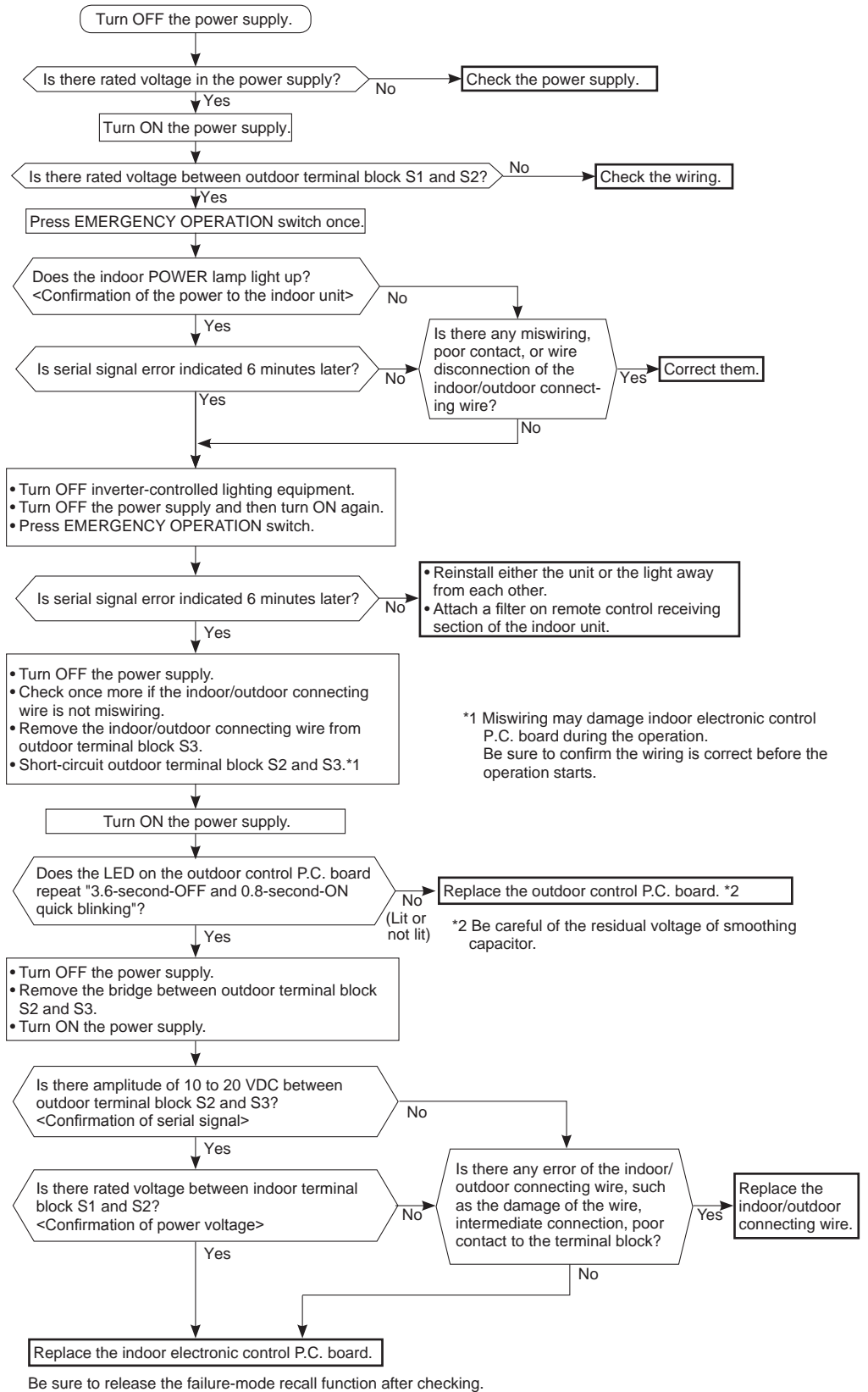
Pattern 1 and 2 is repeatedly displayed alternately. Each pattern is displayed for 10 seconds.

**NOTE:** "Lit" in the table below does not indicate abnormal communication.

Outdoor control P.C. board

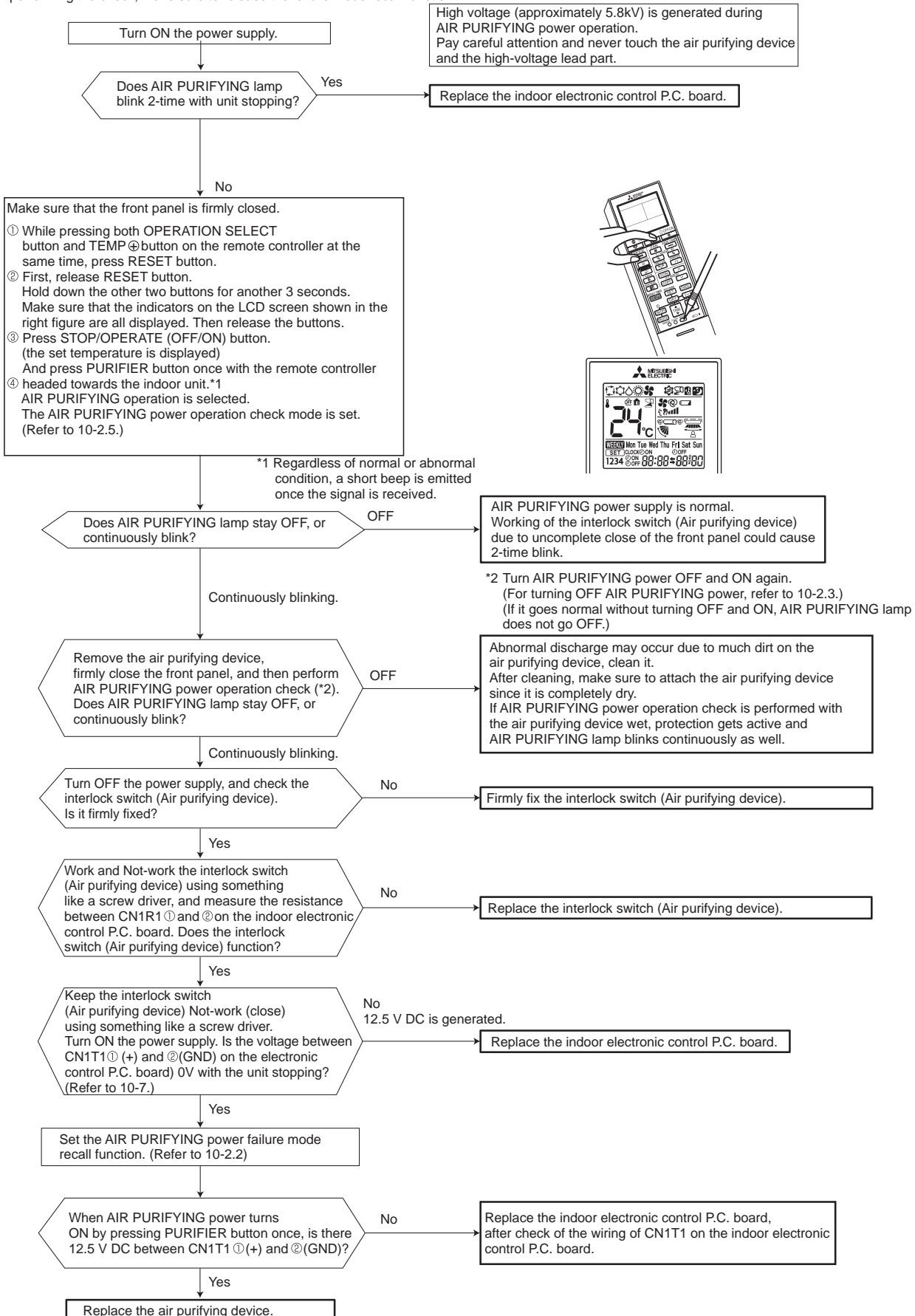


Pattern	LED 1	LED 2	LED 3
1	Unit A status	Unit B status	Lit
2	Unit C status	Unit D status	Not lit
3	Unit E status	—	Blinking

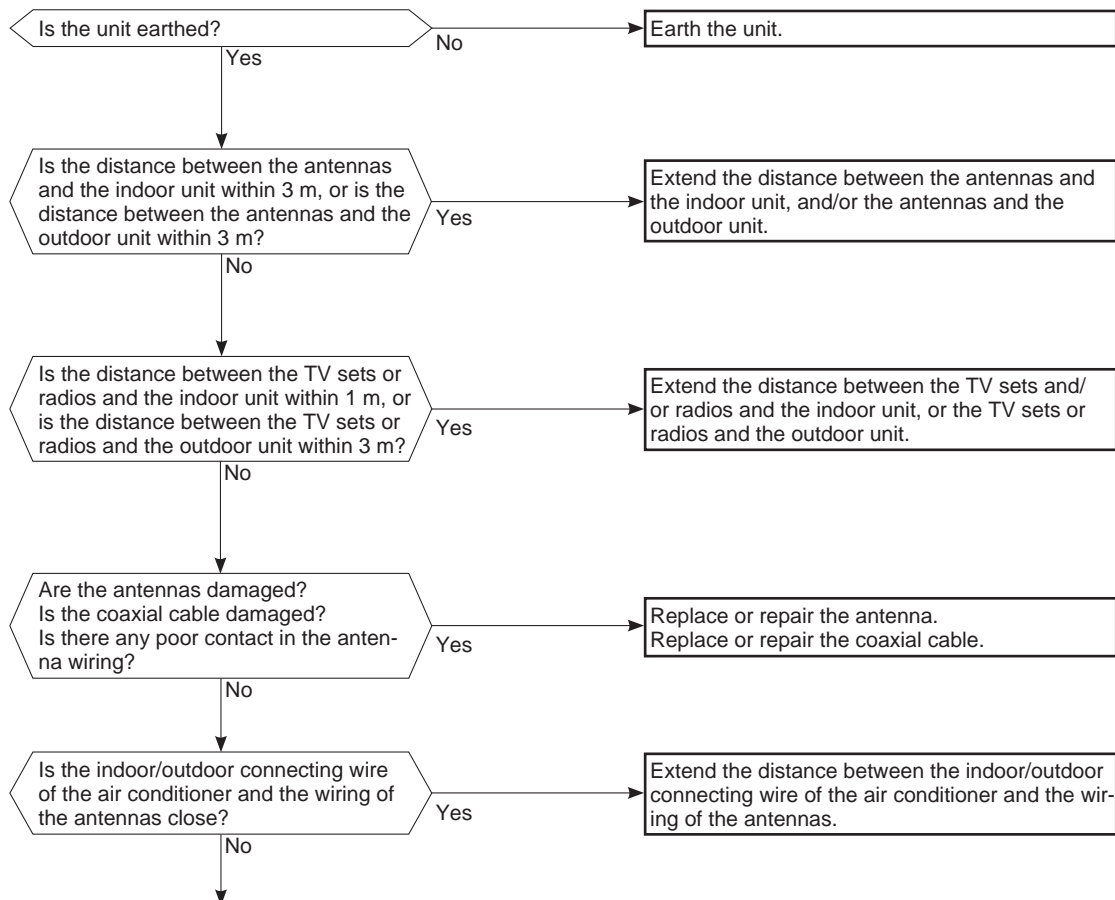


## E Check of AIR PURIFYING power

After performing the check, make sure to release the failure mode recall function.



## F Electromagnetic noise enters into TV sets or radios



Even if all of the above conditions are fulfilled, the electromagnetic noise may enter, depending on the electric field strength or the installation condition (combination of specific conditions such as antennas or wiring).  
 Check the following before asking for service.

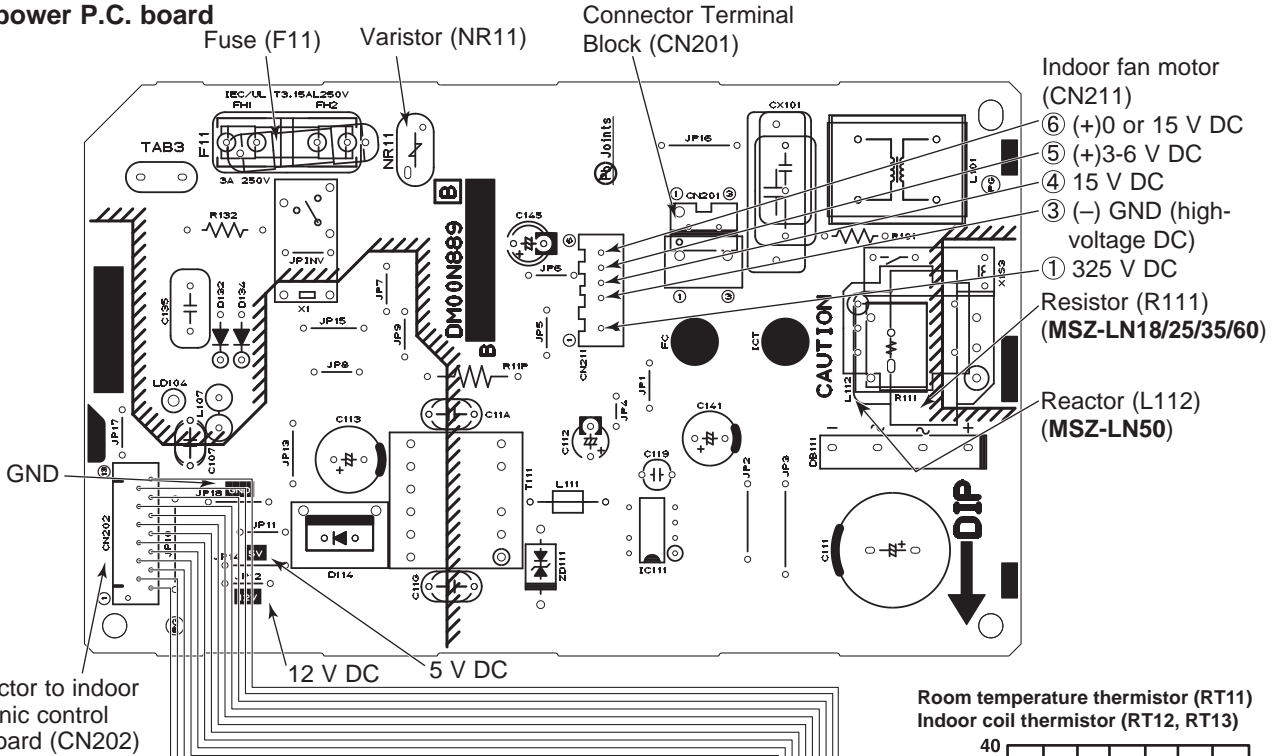
1. Devices affected by the electromagnetic noise  
 TV sets, radios (FM/AM broadcast, shortwave)
2. Channel, frequency, broadcast station affected by the electromagnetic noise
3. Channel, frequency, broadcast station unaffected by the electromagnetic noise
4. Layout of:  
 indoor/outdoor unit of the air conditioner, indoor/outdoor wiring, earth wire, antennas, wiring from antennas, receiver
5. Electric field intensity of the broadcast station affected by the electromagnetic noise
6. Presence or absence of amplifier such as booster
7. Operation condition of air conditioner when the electromagnetic noise enters in
  - 1) Turn OFF the power supply once, and then turn ON the power supply. In this situation, check for the electromagnetic noise.
  - 2) Within 3 minutes after turning ON the power supply, press STOP/OPERATE (OFF/ON) button on the remote controller for power ON, and check for the electromagnetic noise.
  - 3) After a short time (3 minutes later after turning ON), the outdoor unit starts running. During operation, check for the electromagnetic noise.
  - 4) Press STOP/OPERATE (OFF/ON) button on the remote controller for power OFF, when the outdoor unit stops but the indoor/outdoor communication still runs on. In this situation, check for the electromagnetic noise.

## 10-7. TEST POINT DIAGRAM AND VOLTAGE

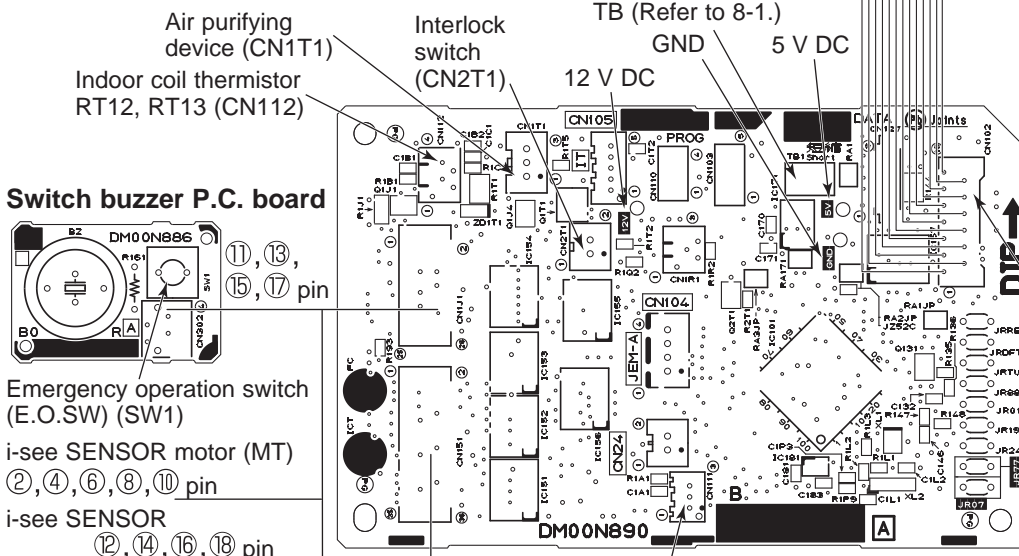
Indoor power P.C. board, Indoor electronic control P.C. board, Display and receiver P.C. board, Switch buzzer P.C. board

MSZ-LN18VGW	MSZ-LN25VGW	MSZ-LN35VGW	MSZ-LN50VGW	MSZ-LN60VGW
MSZ-LN18VGV	MSZ-LN25VGV	MSZ-LN35VGV	MSZ-LN50VGV	MSZ-LN60VGV
MSZ-LN18VGB	MSZ-LN25VGB	MSZ-LN35VGB	MSZ-LN50VGB	MSZ-LN60VGB
MSZ-LN18VGR	MSZ-LN25VGR	MSZ-LN35VGR	MSZ-LN50VGR	MSZ-LN60VGR
MSZ-LN18VG2W	MSZ-LN25VG2W	MSZ-LN35VG2W	MSZ-LN50VG2W	MSZ-LN60VG2W
MSZ-LN18VG2V	MSZ-LN25VG2V	MSZ-LN35VG2V	MSZ-LN50VG2V	MSZ-LN60VG2V
MSZ-LN18VG2B	MSZ-LN25VG2B	MSZ-LN35VG2B	MSZ-LN50VG2B	MSZ-LN60VG2B
MSZ-LN18VG2R	MSZ-LN25VG2R	MSZ-LN35VG2R	MSZ-LN50VG2R	MSZ-LN60VG2R

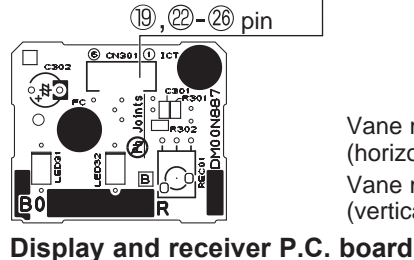
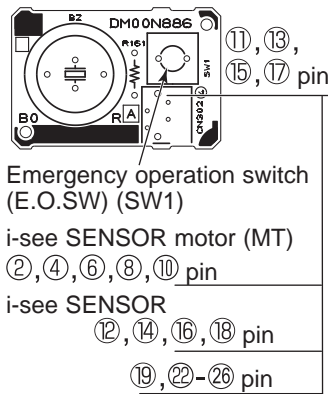
Indoor power P.C. board



Indoor electronic control P.C. board

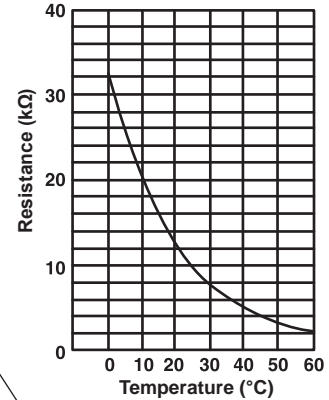


Switch buzzer P.C. board



Display and receiver P.C. board

Room temperature thermistor (RT11)  
Indoor coil thermistor (RT12, RT13)



Connector to indoor power P.C. board (CN102)

Cut the jumper wire JR24 when the room temperature does not reach the set temperature during heating operation. (Refer to 8-6.)

To disable "Auto restart function", cut the Jumper wire to JR77. (Refer to 8-4.)



<"Terminal with locking mechanism" Detaching points>

The terminal which has the locking mechanism can be detached as shown below.

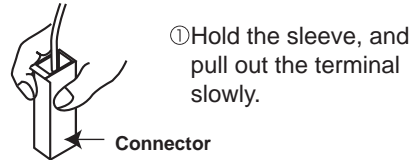
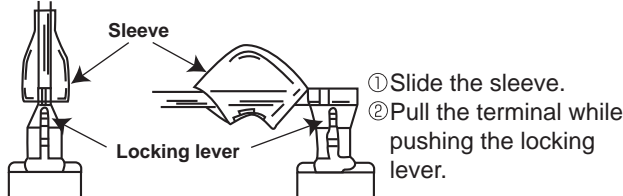
There are 2 types (Refer to (1) and (2)) of the terminal with locking mechanism.

The terminal without locking mechanism can be detached by pulling it out.

Check the shape of the terminal before detaching.

(1) Slide the sleeve and check if there is a locking lever or not.

(2) The terminal with this connector has the locking mechanism.



MSZ-LN18VGW  
MSZ-LN18VGV  
MSZ-LN18VGB  
MSZ-LN18VGR  
MSZ-LN18VG2W  
MSZ-LN18VG2V  
MSZ-LN18VG2B  
MSZ-LN18VG2R

MSZ-LN25VGW  
MSZ-LN25VGV  
MSZ-LN25VGB  
MSZ-LN25VGR  
MSZ-LN25VG2W  
MSZ-LN25VG2V  
MSZ-LN25VG2B  
MSZ-LN25VG2R

MSZ-LN35VGW  
MSZ-LN35VGV  
MSZ-LN35VGB  
MSZ-LN35VGR  
MSZ-LN35VG2W  
MSZ-LN35VG2V  
MSZ-LN35VG2B  
MSZ-LN35VG2R

MSZ-LN50VGW  
MSZ-LN50VGV  
MSZ-LN50VGB  
MSZ-LN50VGR  
MSZ-LN50VG2W  
MSZ-LN50VG2V  
MSZ-LN50VG2B  
MSZ-LN50VG2R

MSZ-LN60VGW  
MSZ-LN60VGV  
MSZ-LN60VGB  
MSZ-LN60VGR  
MSZ-LN60VG2W  
MSZ-LN60VG2V  
MSZ-LN60VG2B  
MSZ-LN60VG2R

NOTE: Turn OFF the power supply before disassembly.

→ : Indicates the visible parts in the photos/figures.  
---> : Indicates the invisible parts in the photos/figures.

OPERATING PROCEDURE	PHOTOS/FIGURES
<p><b>1. Removing the front panel and the panels (U/R/L/F)</b></p> <p><b>Removing the front panel (Photos 1, 2)</b></p> <p>(1) Hold the front panel and open it.</p> <p>(2) Insert a screwdriver deeply into the holes to remove the front panel.</p> <p>Pry off the right and left arm holders by moving the screwdriver down and towards the back wall (Photo 2-1).</p> <p>(3) Remove the safety string from the center of the panel (F).</p> <p><b>NOTE:</b> Hold the panel with your hand while detaching it to avoid injury. (Figure 1)</p>	<p><b>Photo 1</b></p> <p><b>Photo 2</b></p> <p><b>Photo 2-1 (Enlarged view of the front panel stopper)</b></p> <p><b>Figure 1</b></p> <p>Insert a screwdriver into the hole, and move it down and towards the back wall.</p>
<p><b>Photo 2-2</b></p>	



## OPERATING PROCEDURE

### How to install the front panel (Photos 1, 2, 3)

- (1) Attach the right and left arm holders (Photo 2).
- (2) Install the front panel to the indoor unit.
- (3) Attach the safety string to the center of the panel (F).
- (4) Push the locations indicated by the arrows firmly to close the front panel (Figure 2).

### Removing the panel (U) (Photo 1)

- (1) Remove the front panel.
- (2) Insert a flat tool such as a ruler into the groove of the stopper of outer vane (R) (horizontal). Slide the tool and remove the outer vanes (R) (horizontal). Remove the outer vane (L) (horizontal) in the same manner.
- (3) Remove the 2 screw caps on the right and left sides of the panel (U), and remove the 2 screws.
- (4) Disengage the catch on the center of the panel (U), and pull it toward you to remove.

### How to install the panel (U) (Photo 1)

- (1) Press the center of the panel (U) from the front to snap into place.
- (2) Install the 2 screws in the right and left sides of the panel (U), and cover them with 2 screw caps.

### Removing the panel (R) (Photos 1, 2, 3)

- (1) Remove the front panel and the outer vanes (R) (L) (horizontal).
- (2) Remove the panel (U).
- (3) Remove the 2 screws of the panel (R), and pull the top of the panel (R) toward you to remove.

### How to install the panel (R) (Photos 1, 2, 3)

- (1) Install the panel (R) from the bottom to the top.
- (2) Install the 2 screws in the panel (R).

### Removing the panel (L) (Photos 1, 2, 3)

- (1) Remove the front panel and the outer vanes (R) (L) (horizontal).
- (2) Remove the panel (U).
- (3) Remove the screw of the panel (L), and pull the top of the panel (L) toward you to remove.

### How to install the panel (L) (Photos 1, 2, 3)

- (1) Install the panel (L) from the bottom to the top.
- (2) Install the screw in the panel (L).

### Removing the panel (F) (Photo 3)

- (1) Remove the front panel and the outer vanes (R) (L) (horizontal).
- (2) Remove the panels (U) (R) (L).
- (3) Remove the Wi-Fi interface on the right side of the panel (F). Pull out its cable, and remove the cable tie (refer to section 2).
- (4) Remove the panel (F) from the bottom to the top.

### How to install the panel (F)

- (1) Install the panel (F) from the top to the bottom.
- (2) Install the Wi-Fi interface.
- (3) Install the panels (U) (R) (L).
- (4) Install the outer vanes (R) (L) (horizontal) and the front panel.

## PHOTOS/FIGURES

Figure 2

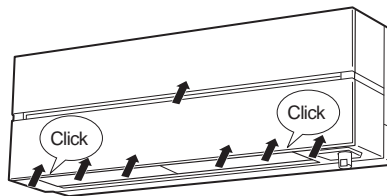
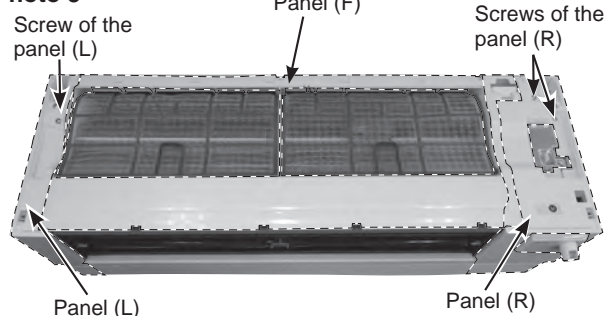


Photo 3



## OPERATING PROCEDURE

### 2. Removing the Wi-Fi interface (Photos 4, 8)

- (1) Remove the front panel and the panels (U) (R) (L).
- (2) Remove the Wi-Fi interface on the right side of the panel (F). Pull out its cable, and remove the cable tie, then remove the panel (F).
- (3) Remove the screw of the V.A. clamp and remove the V.A. clamp.
- (4) Remove the screw of the electrical cover, and remove the electrical cover.
- (5) Disconnect the following connector (Photo 8):  
<Indoor electronic control P.C. board>  
CN110 (Wi-Fi interface)
- (6) Remove the cable of Wi-Fi interface from the water cover.

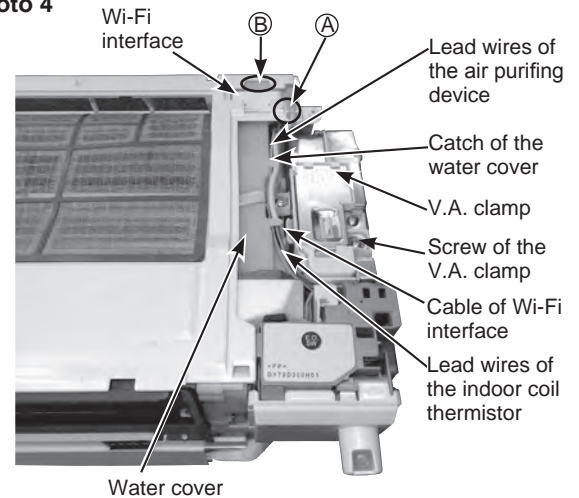
#### How to install the Wi-Fi interface (Photo 4)

**Note:** Install the Wi-Fi interface before installing the panel (R).

- (1) Install the panel (F).
- (2) Fasten the cable of Wi-Fi interface to the part ① of the panel (F) with a cable tie.
- (3) Stow the cable of Wi-Fi interface in the area ②.
- (4) Attach the Wi-Fi interface so its cable side faces away from you.
- (5) Fasten the cable of Wi-Fi interface to the water cover.
- (6) Connect the connector of Wi-Fi interface (CN110) to the indoor electronic control P.C. board.
- (7) Install the electrical cover, and install the screw in the electrical cover.
- (8) Install the V.A. clamp, and install the screw in the V.A. clamp.
- (9) Install the panel (R).
- (10) Install the panels (L) (U).

## PHOTOS/FIGURES

Photo 4



## OPERATING PROCEDURE

### 3. Removing the indoor electrical box (Photos 4, 5, 6, 7, 8)

- (1) Remove the front panel, the outer vanes (R) (L) (horizontal), and the panels (U) (R) (L) (F) (refer to section 1).
- (2) Remove the lead wires of indoor coil thermistor, lead wires of air purifying device, and cable of Wi-Fi interface from the water cover (Photo 4).
- (3) Remove the 2 screws of the CLR earth plate.
- (4) Disengage the catches of the water cover, and remove the water cover.
- (5) Remove the corner box (R) (Photo 5).
- (6) Remove the screw of the V.A. clamp, and remove the V.A. clamp (Photo 4).
- (7) Remove the screw of the electrical cover, and remove the electrical cover (Photo 6).
- (8) Disconnect the following connectors (Photo 8):  
<Indoor electronic control P.C. board>  
CN1J1 (DISPLAY AND i-see SENSOR ASSEMBLY)  
CN2T1 (Limit switch)
- (9) Remove the DISPLAY AND i-see SENSOR ASSEMBLY (Photo 7).
- (10) Disconnect the following connector (Photo 8):  
<Indoor electronic control P.C. board>  
CN110 (Wi-Fi interface)
- (11) Remove the Wi-Fi interface (refer to section 2).
- (12) Remove the screw of the electrical box (Photo 7).
- (13) Disconnect the following connectors (Photo 8):  
<Indoor power P.C. board>  
CN211 (Indoor fan motor)  
<Indoor electronic control P.C. board>  
CN151 (Vane motors)  
CN112 (Indoor coil thermistor)  
CN1T1 (Air purifying device)
- (14) Remove the electrical box.

## PHOTOS/FIGURES

Photo 5

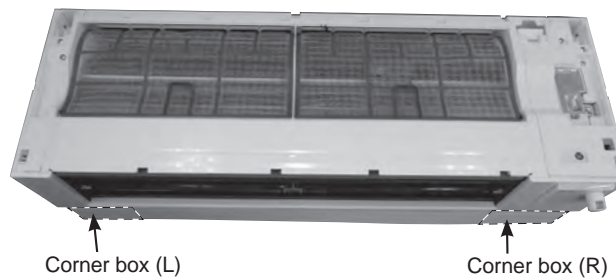


Photo 6

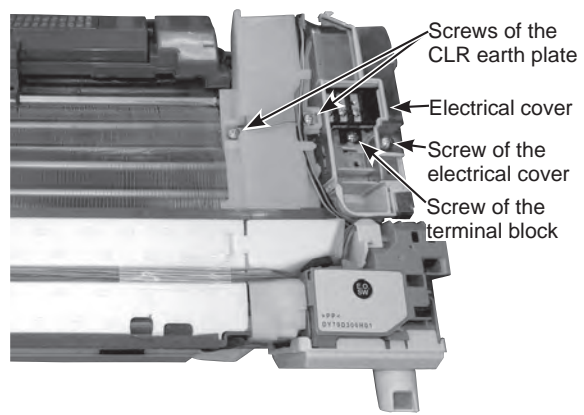
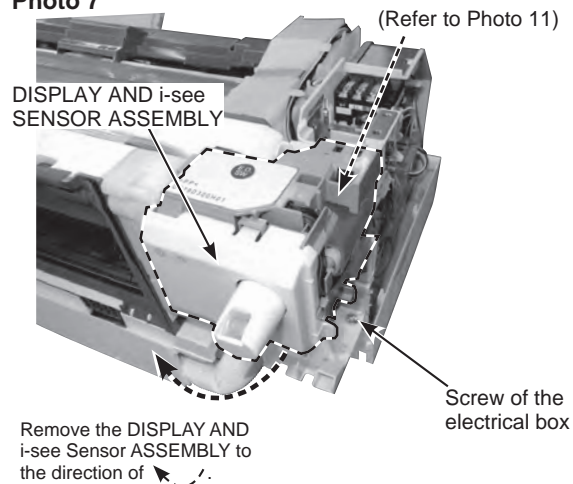


Photo 7



## OPERATING PROCEDURE

### 4. Removing the indoor electronic control P.C. board, the indoor power P.C. board, the indoor terminal block, and the room temperature thermistor

(1) Remove the electrical box (refer to section 3).

#### Removing the indoor terminal block (Photos 6, 8)

- (2) Remove the screw of the terminal block. (Photo 6)
- (3) Disconnect the following connector:  
<Indoor power P.C. board>  
CN202 (To the indoor electronic control P.C. board)
- (4) Remove the heat sink cover.
- (5) Disconnect the connectors of the indoor terminal block (TAB3 and CN201).
- (6) Disconnect the earth wire (LD104) from the earth plate.

#### Removing the indoor electronic control P.C. board and the indoor power P.C. board (Photo 8)

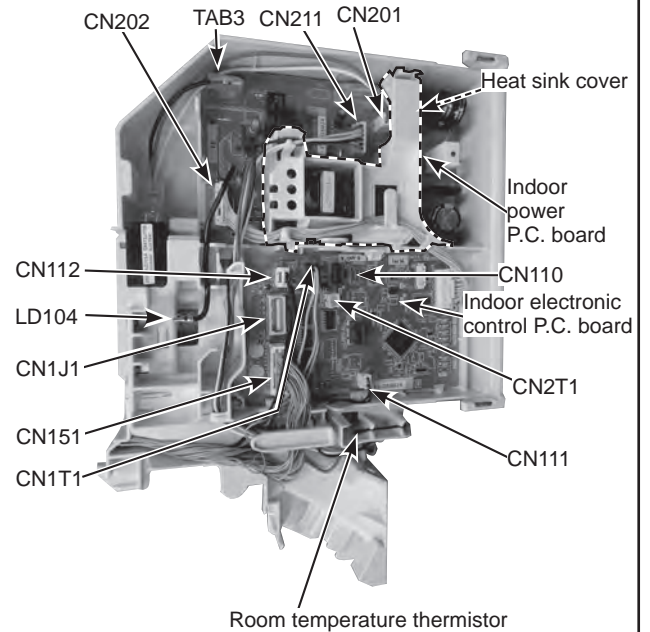
- (2) Disconnect all the connectors on the indoor electronic control P.C. board and the indoor power P.C. board.
- (3) Remove the indoor electronic control P.C. board and the indoor power P.C. board.

#### Removing the room temperature thermistor (Photo 8)

- (2) Disconnect the following connector:  
CN111 (Room temperature thermistor)
- (3) Remove the room temperature thermistor.

## PHOTOS/FIGURES

Photo 8 (Enlarged view of the indoor electronic control P.C. board)



## OPERATING PROCEDURE

## PHOTOS/FIGURES

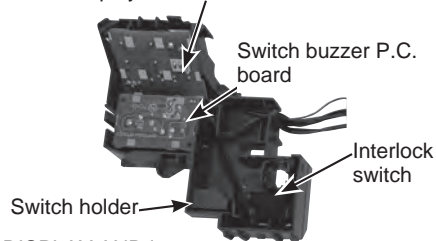
### 5. Removing the DISPLAY AND i-see SENSOR ASSEMBLY, the switch buzzer P.C. board, the display and receiver P.C. board, and the interlock switch (Photo 9)

- (1) Disengage the 4 catches of the display cover, and remove the display cover (Photo 9-1).
- (2) Remove the lead wires of the DISPLAY AND i-see SENSOR ASSEMBLY from the hooks (Photo 9-2).
- (3) Disengage the 4 catches of the switch holder, and remove the switch holder (Photo 9-3).
- (4) Turn over the switch holder. Remove the lead wires of the switch buzzer P.C. board, the display and receiver P.C. board, and the interlock switch from the hook. Remove the switch buzzer P.C. board, the display and receiver P.C. board, and the interlock switch (Photo 9-4).

**Photo 9** (Details of the display, DISPLAY AND i-see SENSOR ASSEMBLY, and board in the switch holder)

**Photo 9-4**

Display and receiver P.C. board

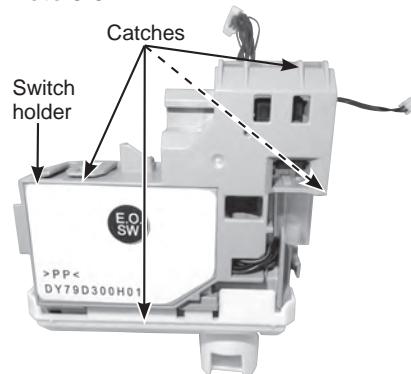


DISPLAY AND i-see SENSOR ASSEMBLY

Display cover

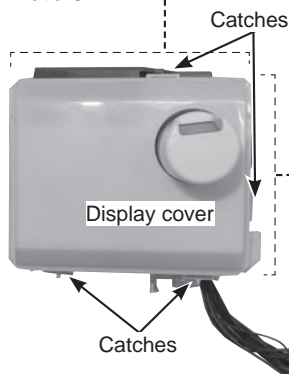
**Exploded view of display cover and DISPLAY AND i-see SENSOR ASSEMBLY (Switch buzzer P.C. board, display and receiver P.C. board)**

**Photo 9-3**



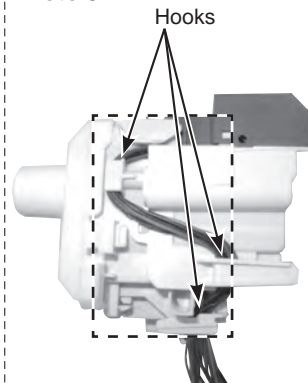
**Top view of DISPLAY AND i-see SENSOR ASSEMBLY**

**Photo 9-1**



**Front view of DISPLAY AND i-see SENSOR ASSEMBLY**

**Photo 9-2**



**Right side view of DISPLAY AND i-see SENSOR ASSEMBLY**

## OPERATING PROCEDURE

### 6. Removing the outer vane motors (horizontal) (Photos 8, 10, 11, 12, 13)

- (1) Remove the front panel, the outer vanes (R) (L)(horizontal), the panels (U) (R) (L) (F), the corner boxes (R) (L), Wi-Fi interface, DISPLAY and i-see SENSOR ASSEMBLY, V.A. clamp, and the electrical cover.
- (2) Remove the following connector (Photo 8): <Indoor electronic control P.C. board> CN151 (Vane motors)
- (3) Pull out the drain hose from the nozzle assembly.
- (4) Pull and remove the nozzle assembly (catches on left, right, and center) (Photo 10).
- (5) Cut off the cable tie to secure the lead wires on the right side of the nozzle assembly (Photo 12).
- (6) Remove the tape to secure the lead wires and the aluminum tape on the front of the nozzle assembly (Photo 11).

#### Removing outer vane motor (R) (horizontal) (Photo 12)

- (7) Loosen the lead wires, and disconnect the connector of the outer vane motor (R) (horizontal).
- (8) Remove the 2 screws of the outer vane motor (R) (horizontal).
- (9) Remove the outer vane motor (R) (horizontal).

#### Removing outer vane motor (L) (horizontal) (Photo 13)

- (10) Loosen the lead wires, and disconnect the connector of the outer vane motor (L) (horizontal).
- (11) Remove the 2 screws of the outer vane motor (L) (horizontal).
- (12) Remove the outer vane motor (L) (horizontal).

## PHOTOS/FIGURES

Photo 10

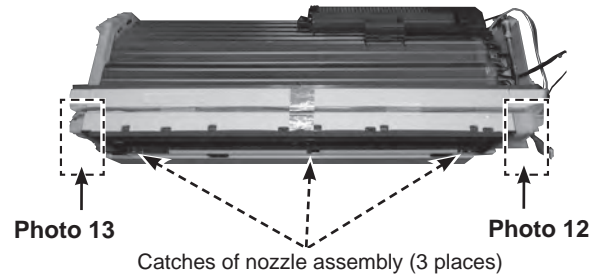


Photo 11 (Front view of nozzle assembly)

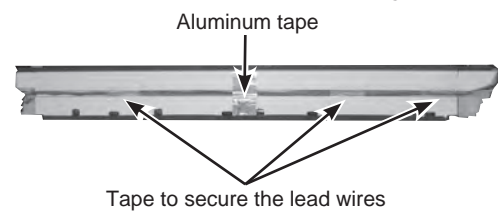


Photo 12 Outer vane motor (R) (horizontal)

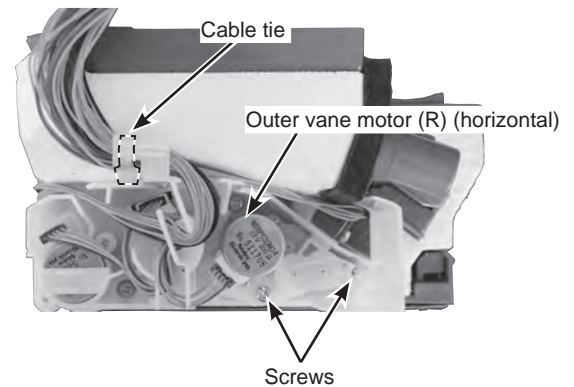
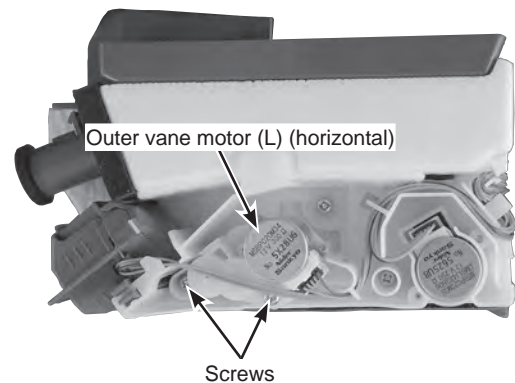


Photo 13 Outer vane motor (L) (horizontal)





## OPERATING PROCEDURE

### 7. Removing the vane motor units (L) (R) (vertical) and the vane motors (horizontal)

- (1) Remove the front panel, the outer vanes (R) (L) (horizontal), the inner vanes (R) (L), the vane slide assembly, the panels (U) (R) (L) (F), the corner boxes (R) (L), Wi-Fi interface, DISPLAY and i-see SENSOR ASSEMBLY, V.A. clamp, and the electrical cover.
- (2) Remove the panel (F) (Photo 3).
- (3) Remove the following connector (Photo 8):  
<Indoor electronic control P.C. board>  
CN151 (Vane motors)
- (4) Pull out the drain hose from the nozzle assembly. Pull and remove the nozzle assembly (catches on left, right, and center) (Photo 10).
- (5) Cut off the cable tie to secure the lead wires on the right side of the nozzle assembly (Photo 12).
- (6) Remove the tape to secure the lead wires and the aluminum tape on the front of the nozzle assembly. (Photo 11)

#### Removing the vane motor (R) (horizontal) and the vane motor (horizontal) (Photo 14, 15)

- (7) Remove the 3 screws of the vane motor unit (R) (horizontal) and remove the lead wires of the vane motor (R) (vertical), the vane motor (R) (horizontal) and the vane motor (horizontal).
- (8) Remove the 2 screws of the vane motor (R) (horizontal) from the backside of the vane motor unit (R) (horizontal), and remove the vane motor (R) (horizontal).
- (9) Remove the 2 screws of the vane motor (horizontal) from the backside of the vane motor unit (R) (horizontal), and remove the vane motor (horizontal).

#### Removing the vane motor unit (R) (vertical) (Photo 15)

- (10) Disengage the link of the vane motor unit (R) (vertical).
- (11) Remove the screw indicated in , and remove the vane motor unit (R) (vertical).

#### Removing the vane motor (L) (horizontal) (Photo 16)

- (12) Disengage the link of the vane motor unit (L) (vertical).
- (13) Remove the 3 screws indicated in (Photo 16).
- (14) Remove the 2 screws of the vane motor (L) (horizontal) from the backside of the vane motor unit (L) (horizontal), and remove the vane motor (horizontal).

#### Removing the vane motor unit (L) (vertical) (Photo 17)

- (15) Disengage the catch of the vane motor unit (L) (vertical), and remove the vane motor unit (L) (vertical).

## PHOTOS/FIGURES

Photo 14

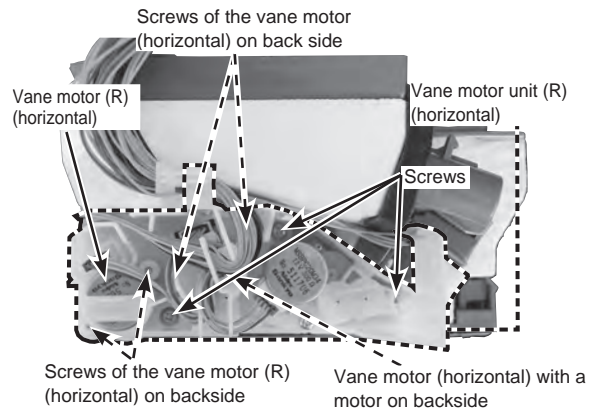


Photo 15 Vane motor unit (R) (vertical)

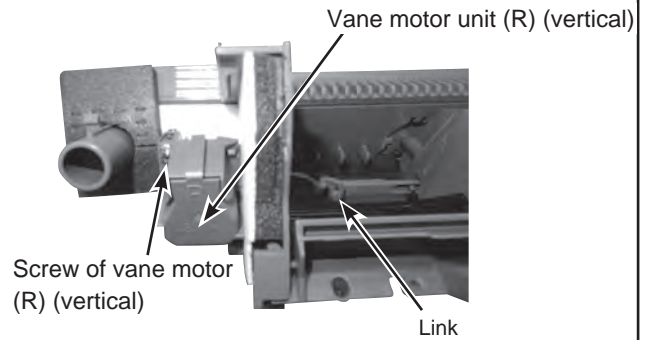


Photo 16

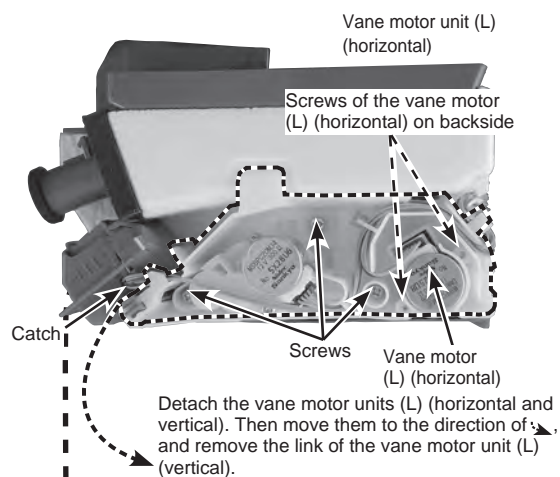
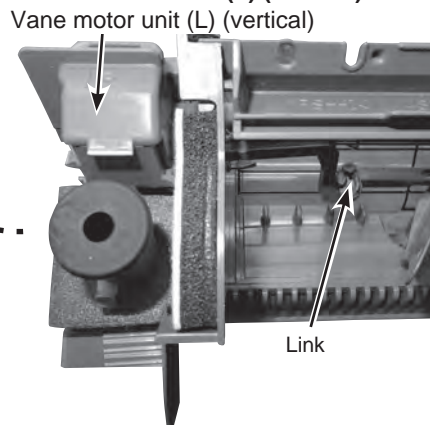


Photo 17 Vane motor unit (L) (vertical)





## OPERATING PROCEDURE

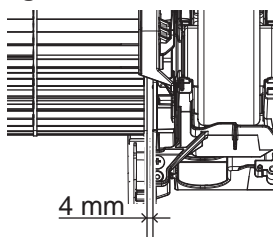
### 8. Removing the air purifying device (Photo 8, 18)

- (1) Remove the front panel, the outer vanes (R) (L)(horizontal), the panels (U) (R) (L) (F), the corner box (R), V.A. clamp and the electrical cover.
- (2) Remove the lead wires from the water cover.
- (3) Disconnect the following connector (Photo 8):  
<Indoor electronic control P.C. board>  
CN1T1 (Air purifying device)
- (4) Remove the screw of the air purifying device support.
- (5) Remove the air purifying device support.

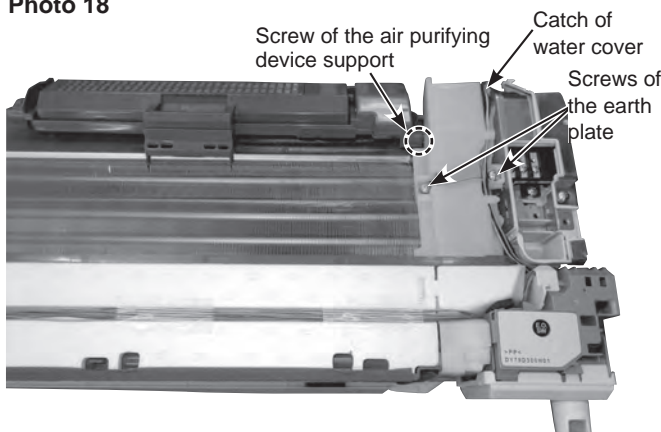
### 9. Removing the line flow fan, the indoor fan motor assembly, the indoor coil thermistor, and the heat exchanger (Photo 4, 18, 19, 20, 21, 22)

- (1) Remove the front panel, the outer vanes (R) (L)(horizontal), the panels (U) (R) (L) (F), and the corner boxes (R) (L), Wi-Fi interface, DISPLAY and i-see SENSOR ASSEMBLY, the electrical box, the nozzle assembly and the air purifying device.
  - (2) Loosen the screw inside the right side of the line flow fan (Photo 19).
  - (3) Remove the 3 screws of the fan motor assembly.  
Pull the fan motor assembly slightly toward you, and remove it by pulling to the right (Photo 20).
  - (4) Remove the indoor coil thermistor from the heat exchanger.
  - (5) Remove the 2 screws of the hairpin holder on the left side of the heat exchanger. Raise the left side of the heat exchanger, and pull the line flow fan to the lower left to remove (Photo 21).
  - (6) Disengage the 2 catches on the right side of the heat exchanger, and remove the heat exchanger (Photo 22).
- \*1 When attaching the line flow fan, screw the line flow fan so 4 mm gap is provided between the right end of the line flow fan and the right wall of the air passage of the box (Figure 1).

**Figure 1**

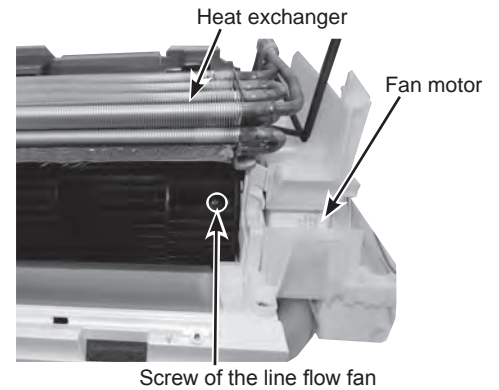


**Photo 18**

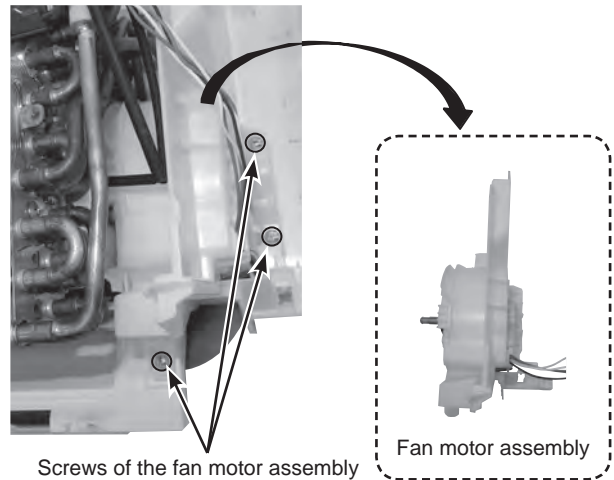


## PHOTOS/FIGURES

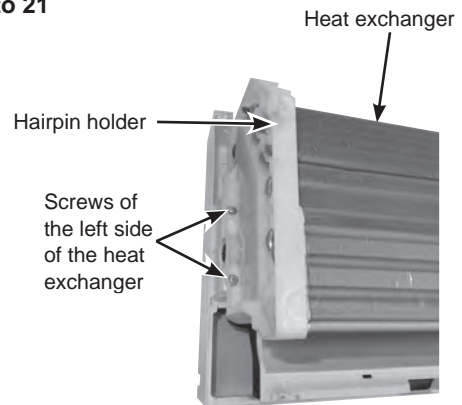
**Photo 19**



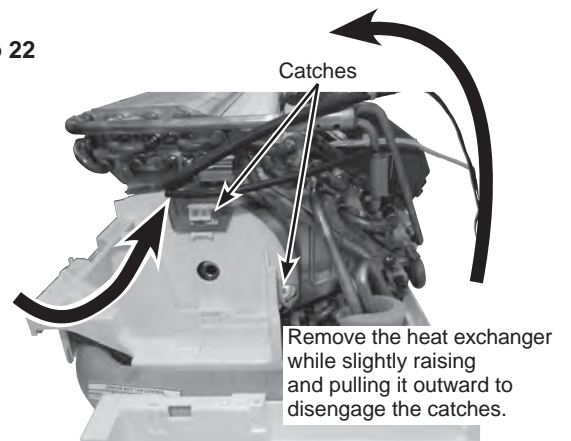
**Photo 20**



**Photo 21**



**Photo 22**



## Fixing the indoor coil thermistor

※ There are 2 forms of parts for fixing the indoor coil thermistor.

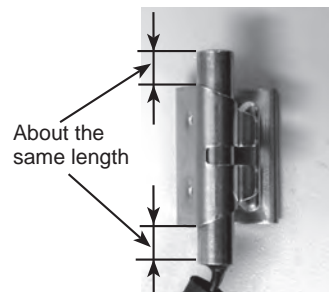
**Clip shape**



**Holder shape**



When fixing the indoor coil thermistor to the clip-shape/holder-shape part, the lead wire should point down.



### Position and procedure for mounting the clip-shape part

1. Set the indoor coil thermistor in the center of the clip-shape part.



2. Check the (marked) mounting position.



3. Mount the clip-shape part.



#### NOTE:

- Take care to avoid loss and accidental falling of the clip-shape part inside the unit.
- Mount the clip-shape part on the marked position.
- Do not pull the lead wire when removing the indoor coil thermistor.

## MITSUBISHI ELECTRIC CORPORATION

HEAD OFFICE: TOKYO BUILDING, 2-7-3, MARUNOUCHI, CHIYODA-KU, TOKYO 100-8310, JAPAN

© Copyright 2016 MITSUBISHI ELECTRIC CORPORATION

Issued: Dec. 2019. No. OBH766 REVISED EDITION-C

Issued: Mar. 2018. No. OBH766 REVISED EDITION-B

Issued: Sep. 2017. No. OBH766 REVISED EDITION-A

Published: Dec. 2016. No. OBH766

Made in Japan

Specifications are subject to change without notice.